

Queue Implementations

Tiziana Ligorio

Hunter College of The City University of New York

Today's Plan



Announcements

Recap

Queue Implementations

Announcements

Read Interlude 8 - STL

Recap

FIFO structure: First In First Out

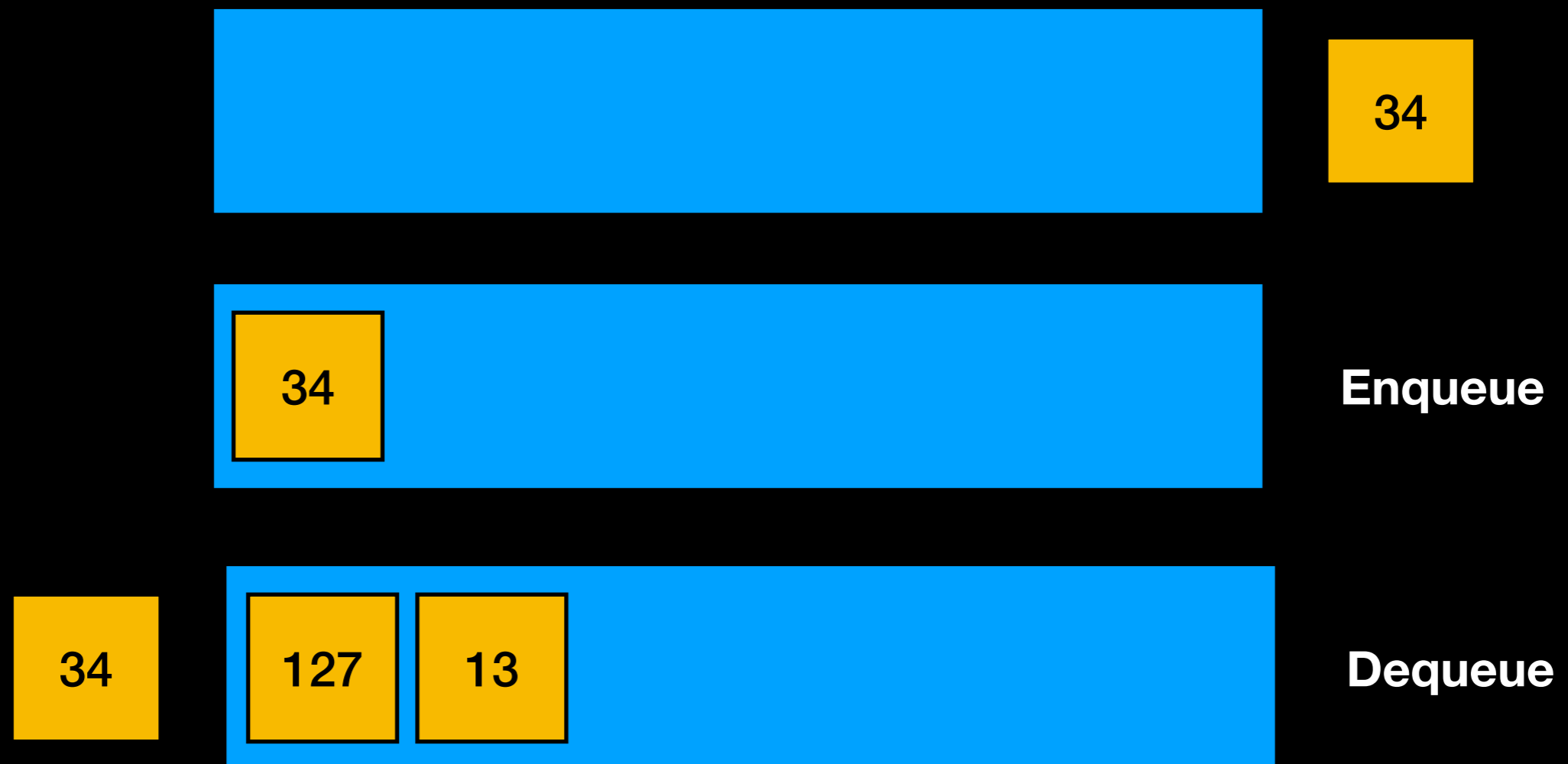

Queue ADT

```
#ifndef QUEUE_H_
#define QUEUE_H_

template<class T>
class Queue
{

public:
    Queue();
    void enqueue(const T& new_entry); // adds an element to back queue
    void dequeue(); // removes element from front of queue
    T front() const; // returns a copy of element at the front of queue
    int size() const; // returns the number of elements in the queue
    bool isEmpty() const; // returns true if no elements in queue, false otherwise

private:
    //implementation details here

}; //end Queue

#include "Queue.cpp"
#endif // QUEUE_H_`
```

Choose a Data Structure

Array?



Vector?

Linked List?

We are looking to enqueue and dequeue in $O(1)$ time

Recall Analysis for Stack

Amortized Analysis

	Big-O	Size unbounded
Array	$O(1)$	
Vector	$O(1)+$	
Linked Chain	$O(1)$	

What is the main difference
btw stack and queue?

Singly Linked Chain

**Where is front?
Where is back?**

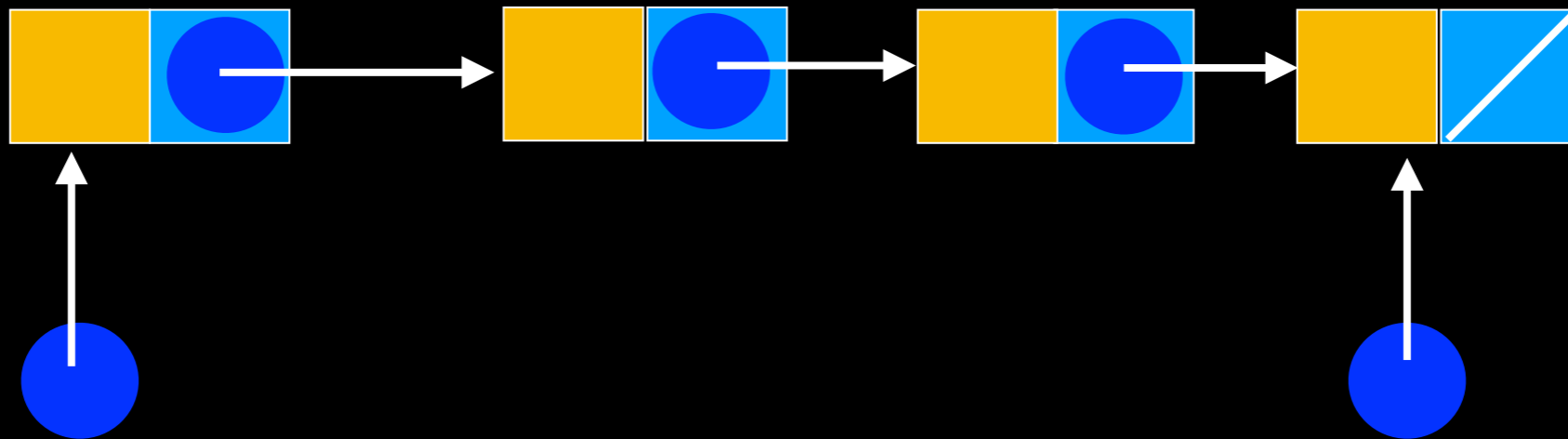

Singly Linked Chain

Deleting here is not $O(1)$
Because we don't have
pointer to previous node

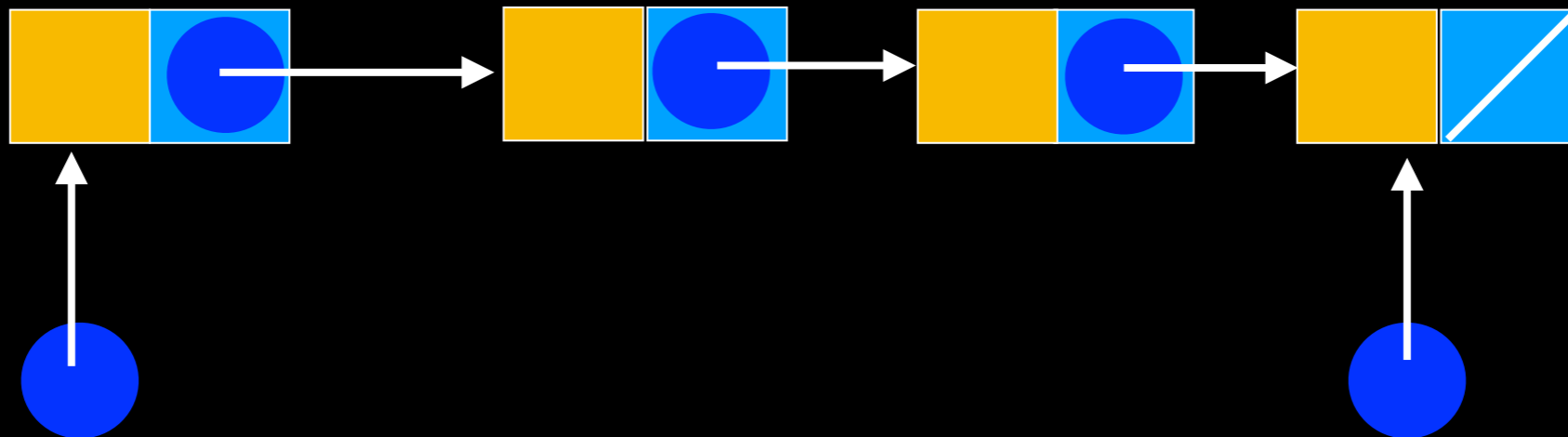

Singly Linked Chain

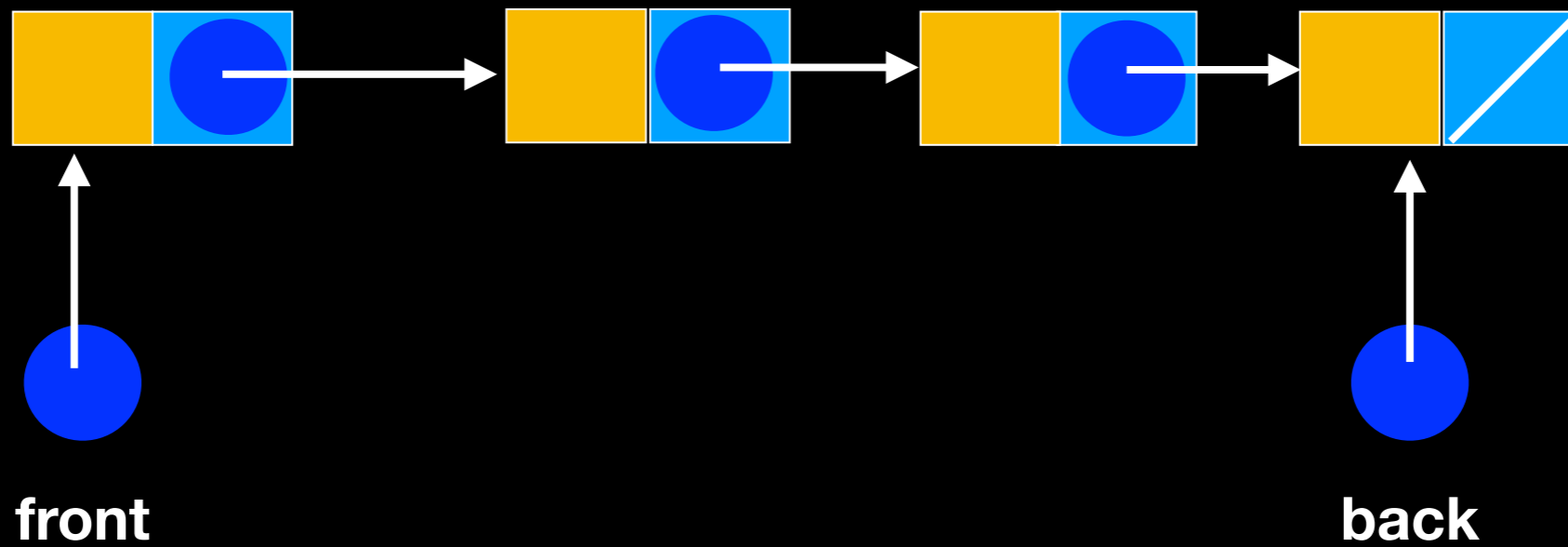

Singly Linked Chain

enqueue

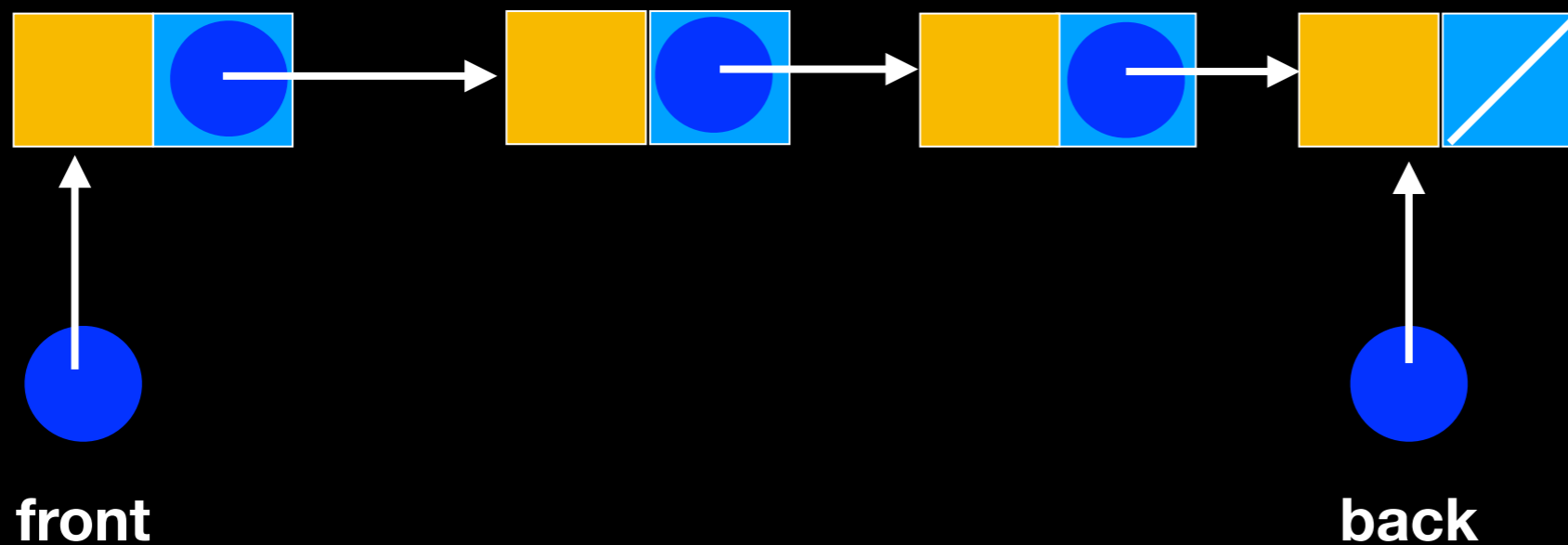

Singly Linked Chain

enqueue

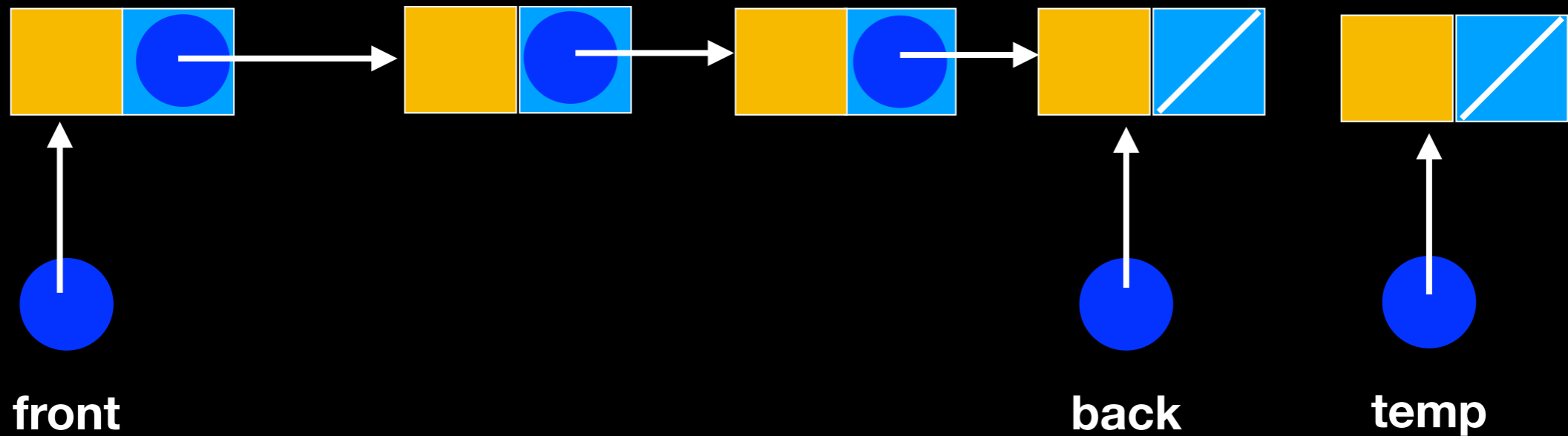

Singly Linked Chain

enqueue

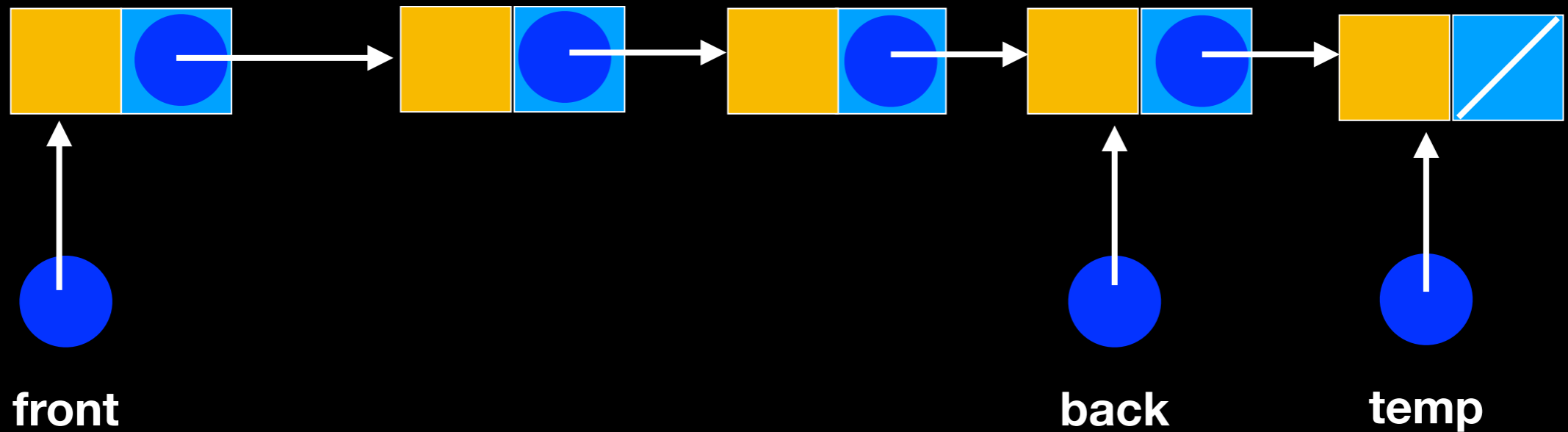

Singly Linked Chain

enqueue

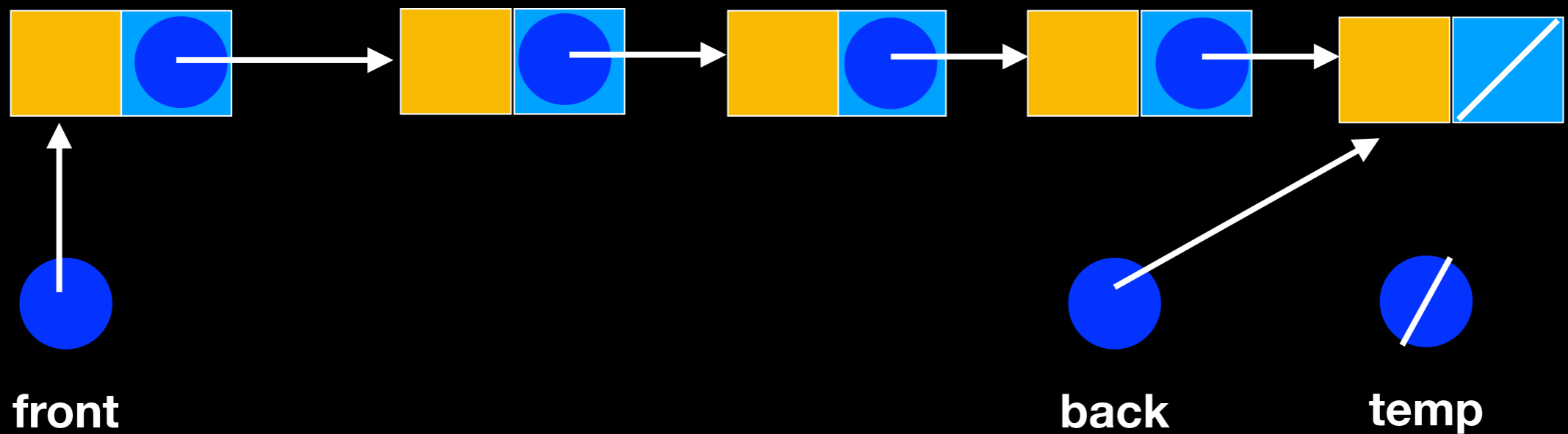

Singly Linked Chain

enqueue

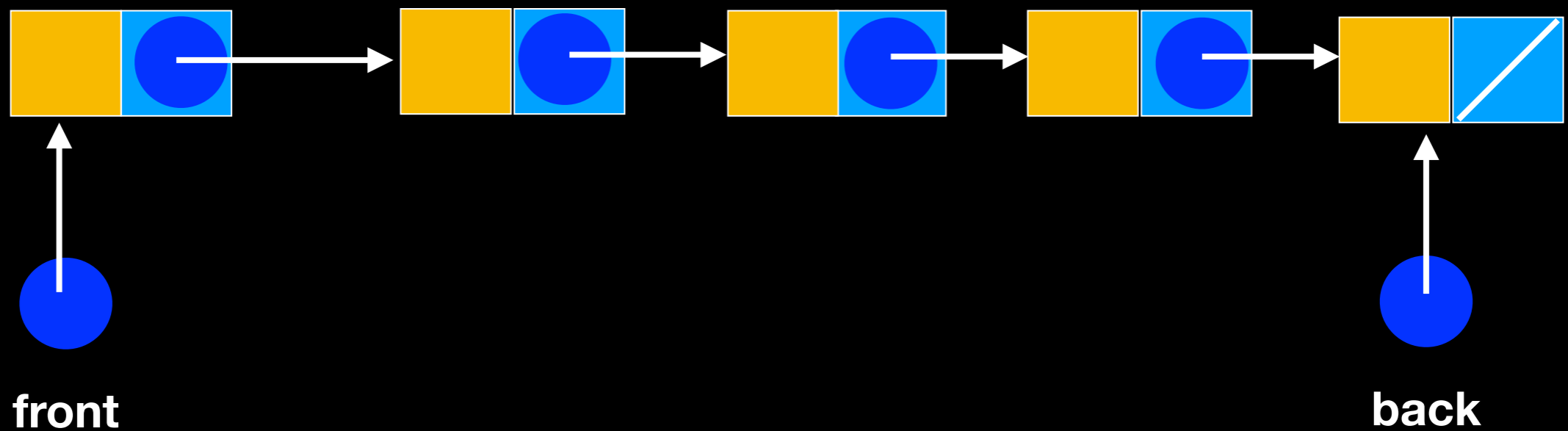

Singly Linked Chain

dequeue

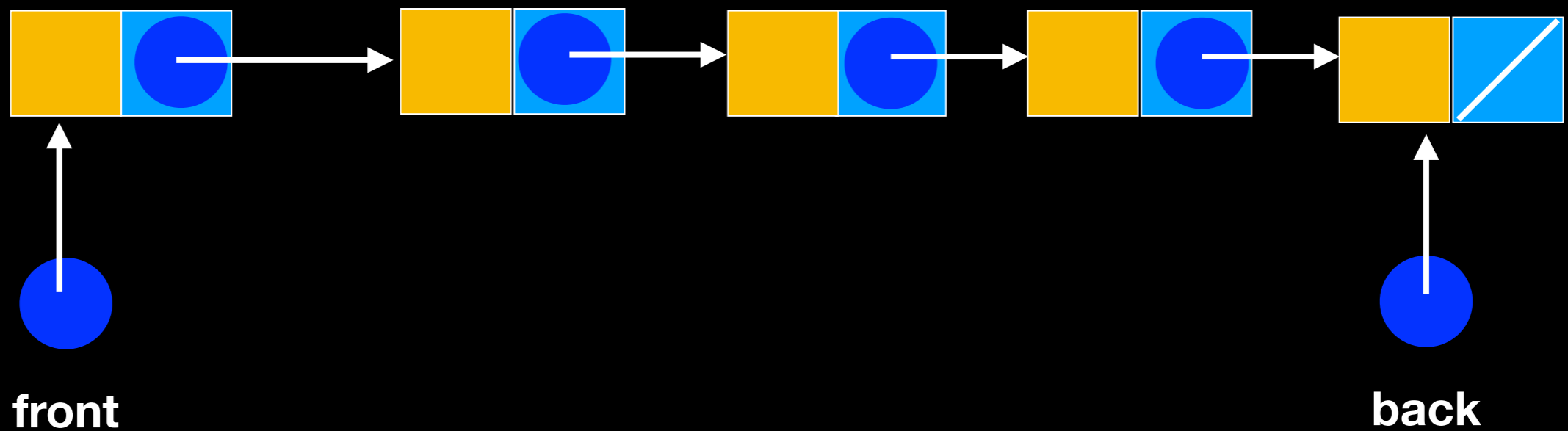

Singly Linked Chain

dequeue

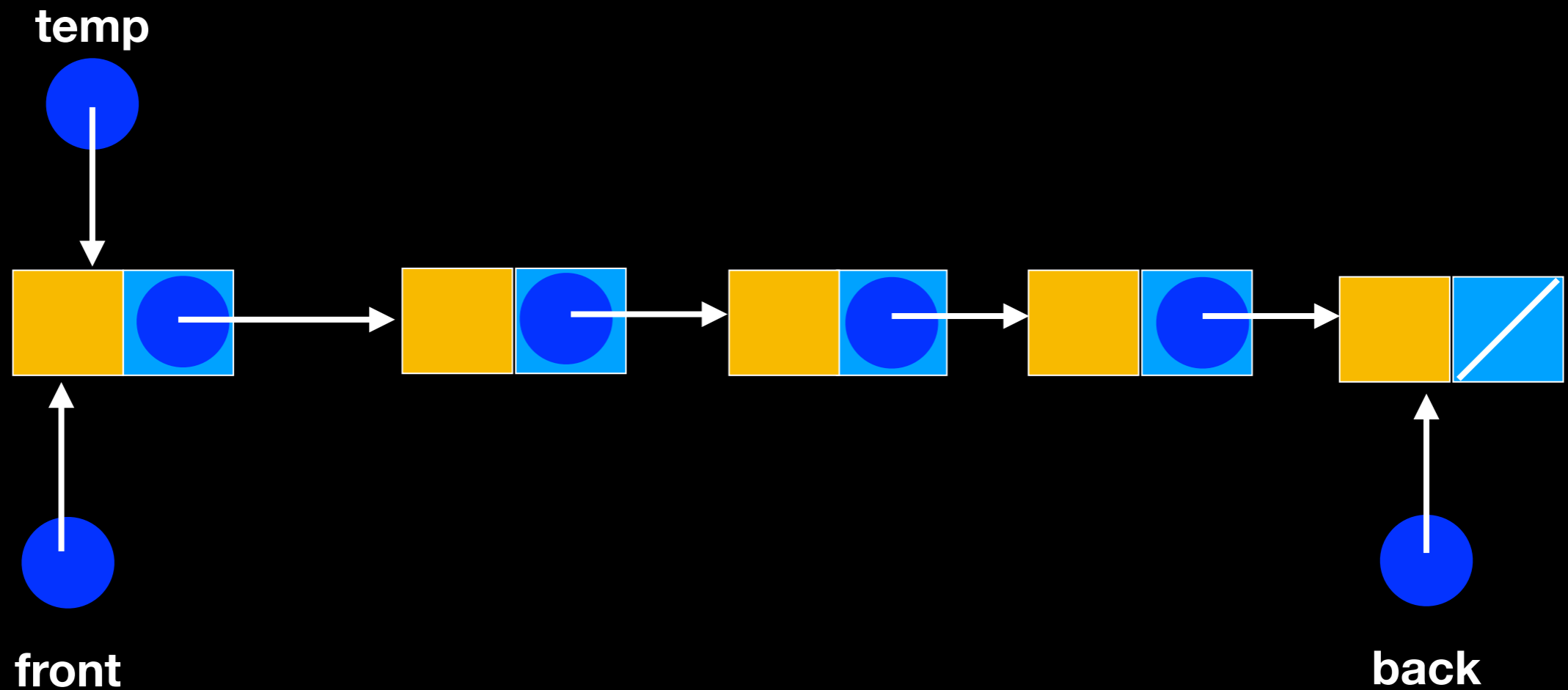

Singly Linked Chain

dequeue

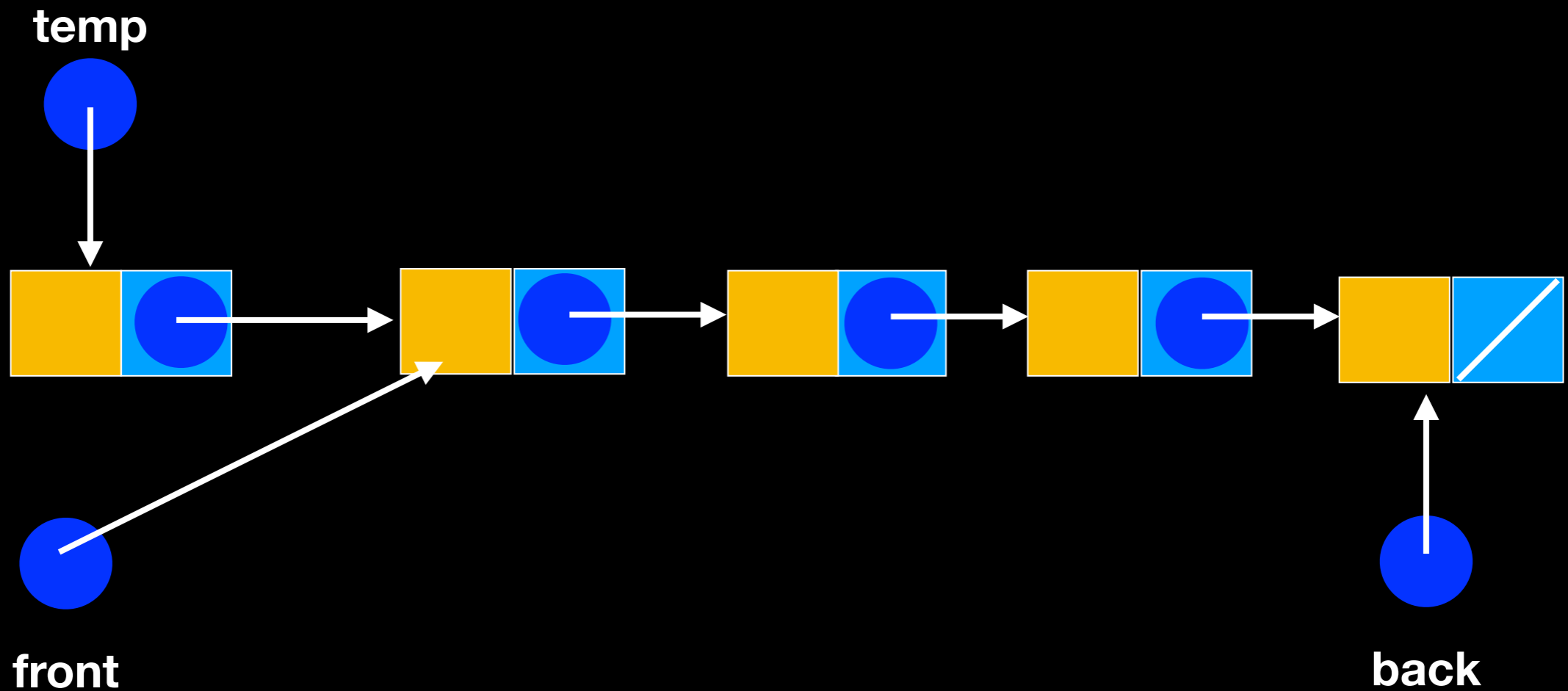

Singly Linked Chain

dequeue

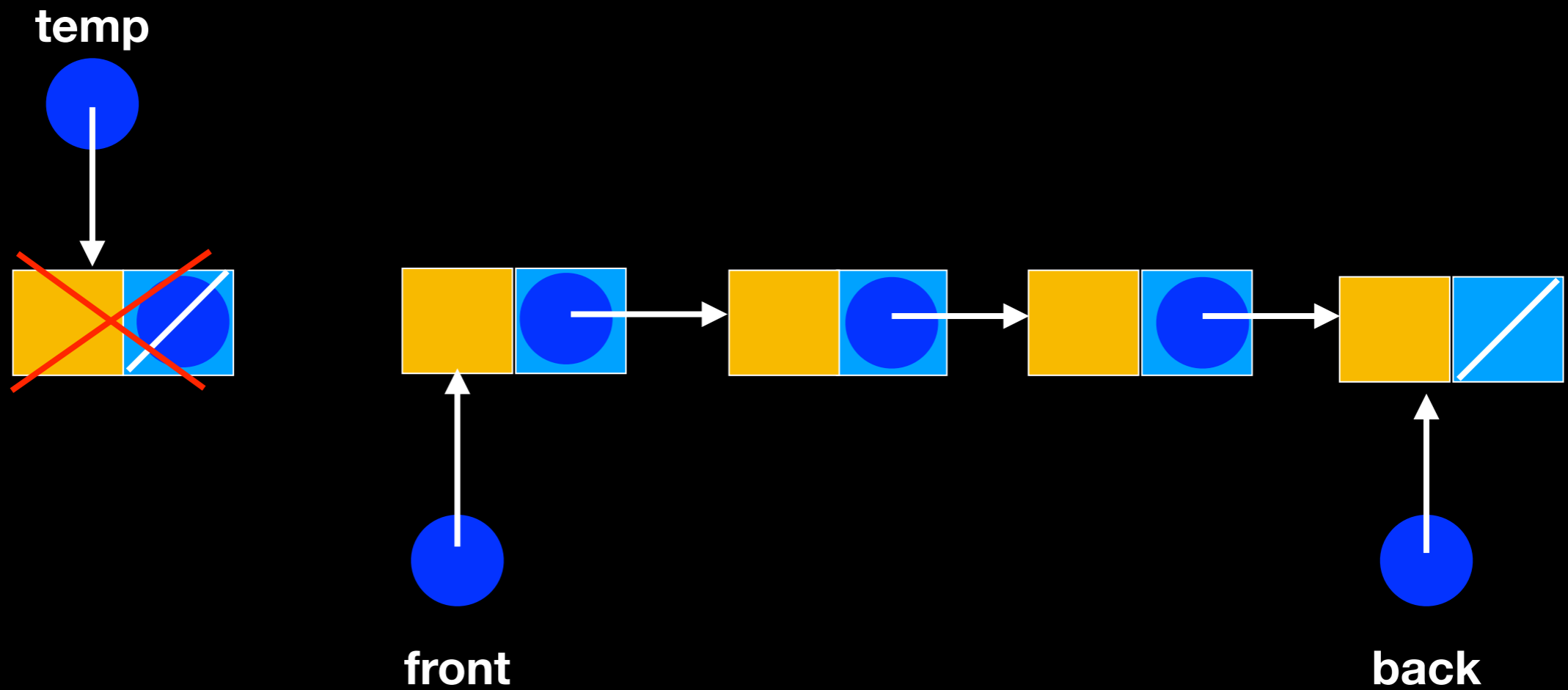

Singly Linked Chain

dequeue

temp

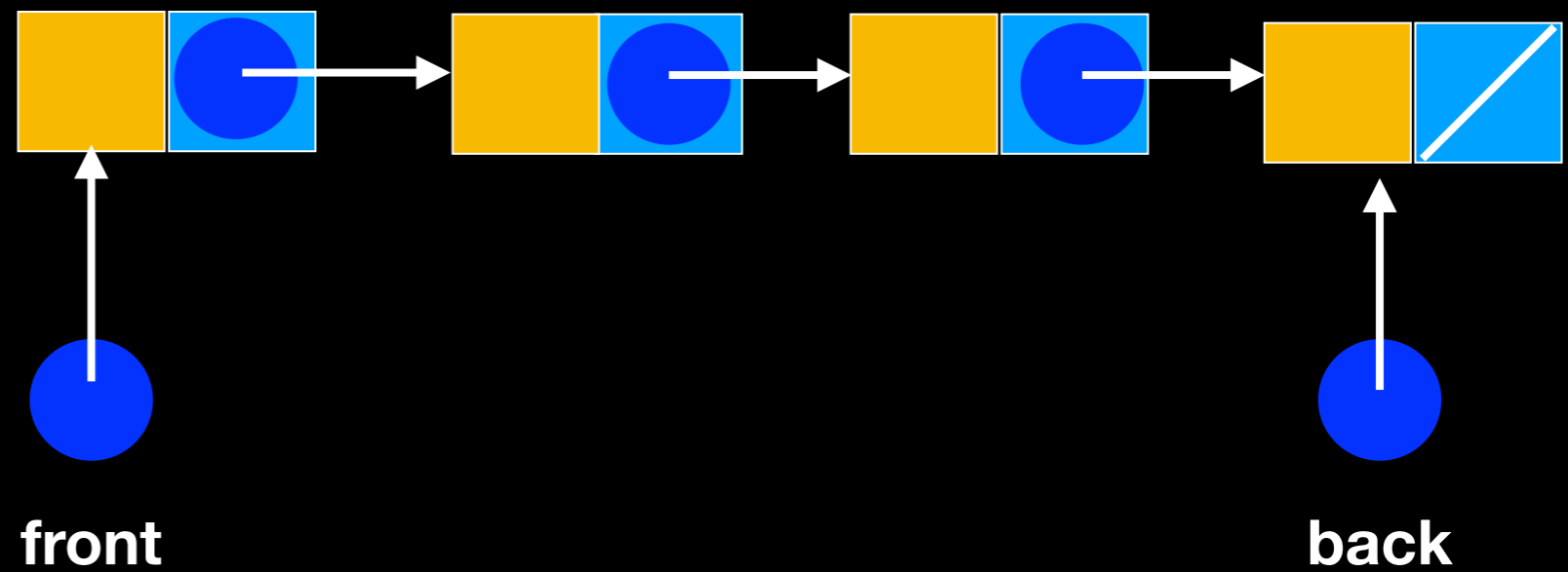

Singly Linked Chain

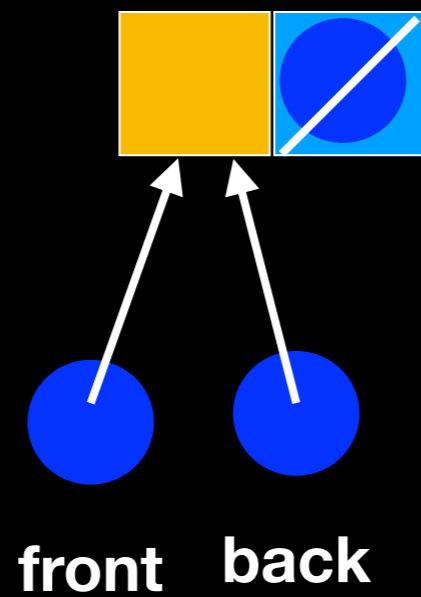

That's it!

Singly Linked Chain

An Alternative: A Circular Linked Chain

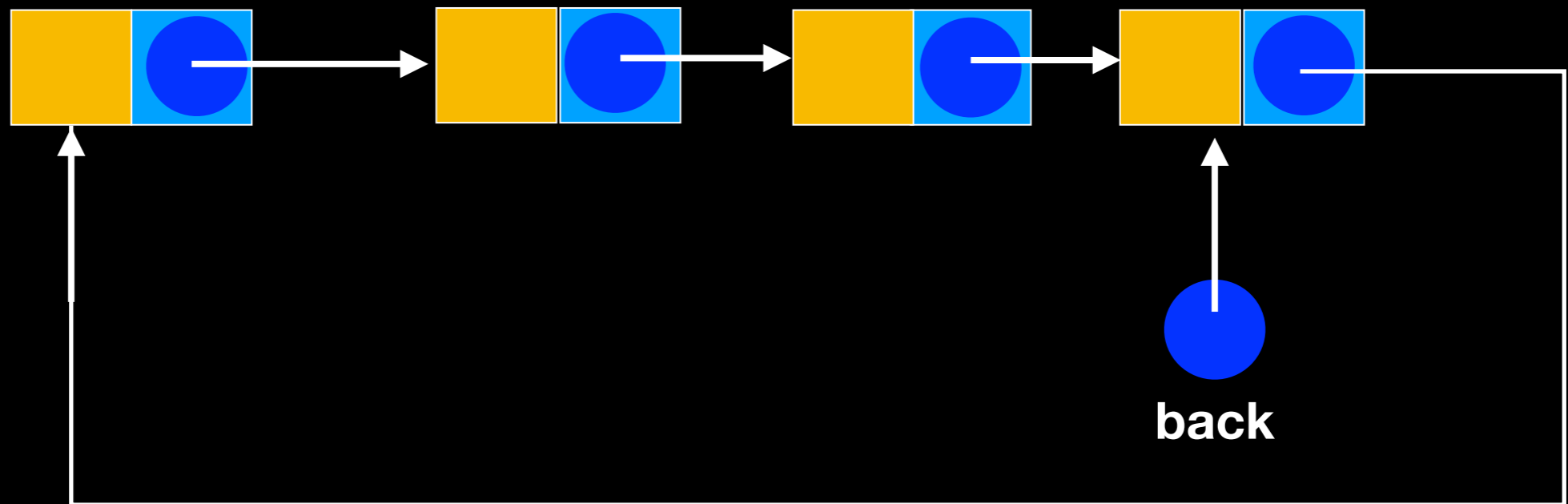

Singly Linked Chain

enqueue

**An Alternative:
A Circular Linked Chain**

Instantiate new node

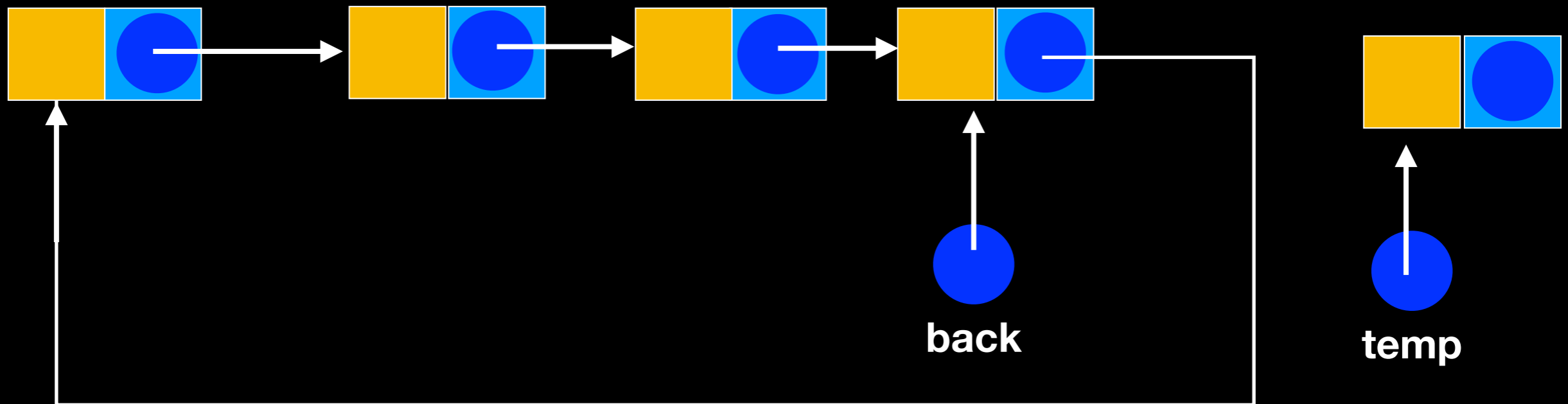

Singly Linked Chain

enqueue

**An Alternative:
A Circular Linked Chain**

```
temp->setNext (back->getNext ( ) ) ;
```

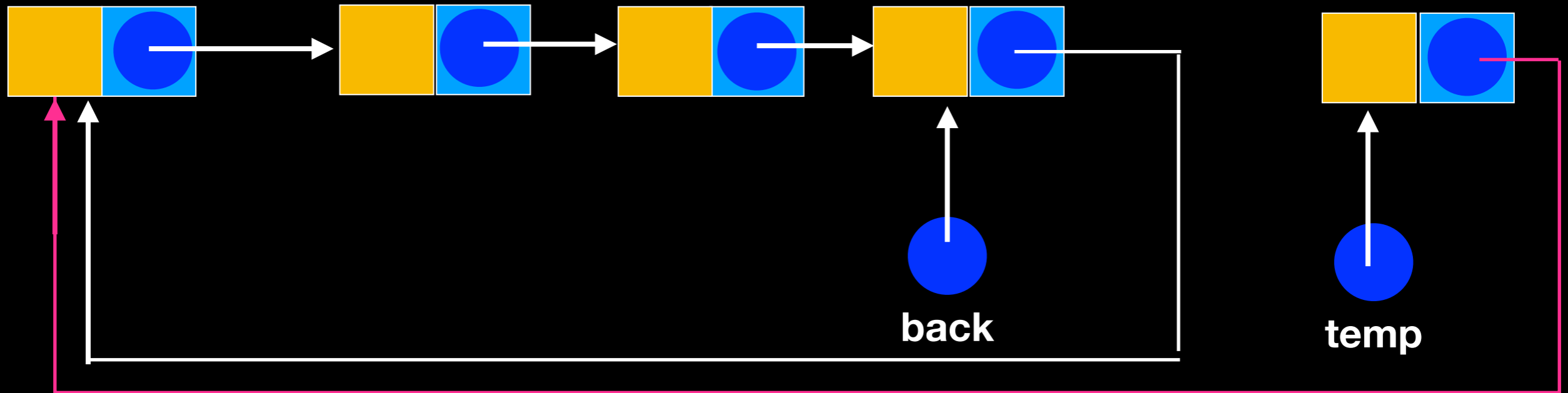

Singly Linked Chain

enqueue

**An Alternative:
A Circular Linked Chain**

```
back->setNext(temp);
```

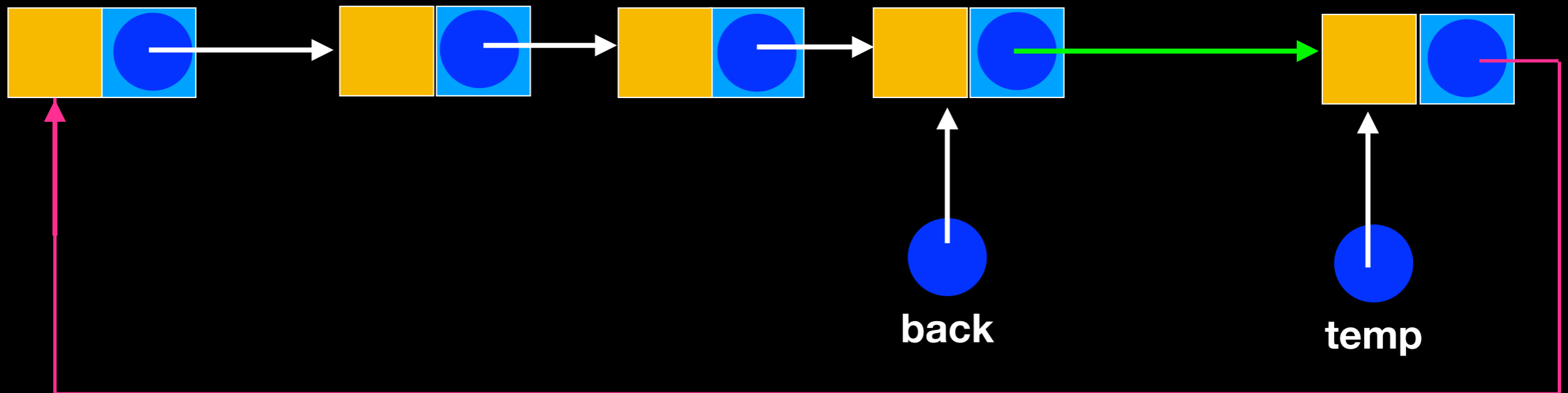

Singly Linked Chain

enqueue

**An Alternative:
A Circular Linked Chain**

```
back = temp;
```

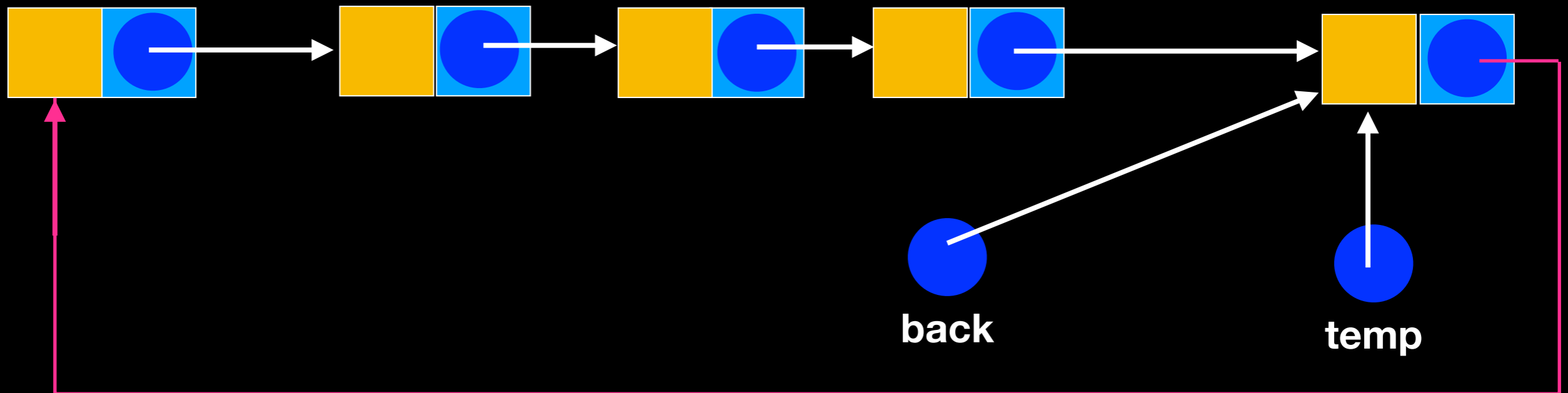

Singly Linked Chain

enqueue

**An Alternative:
A Circular Linked Chain**

```
temp = nullptr;
```

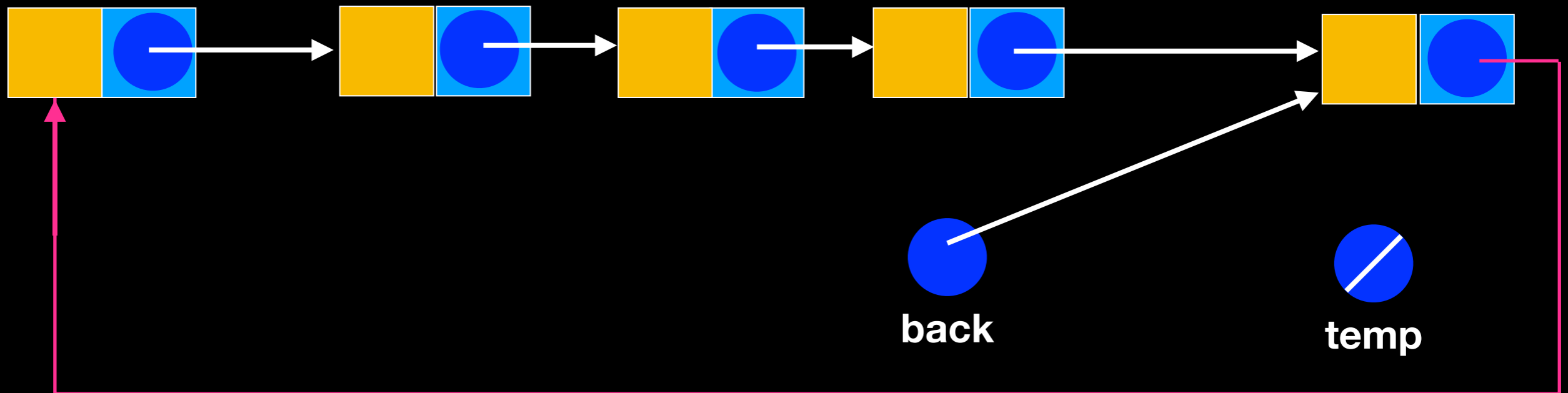

Singly Linked Chain

enqueue

**An Alternative:
A Circular Linked Chain**

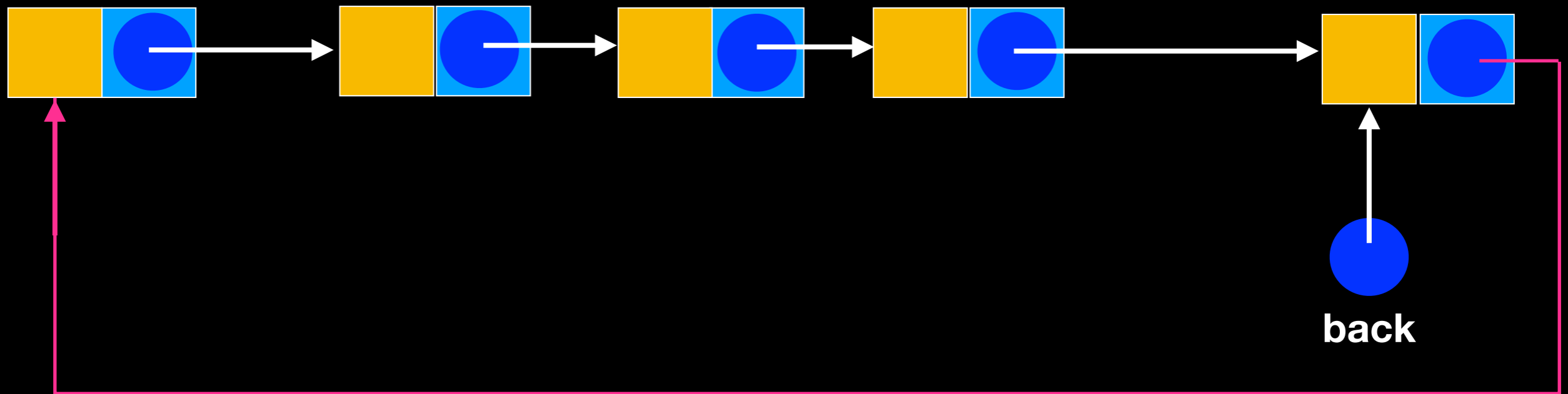

Singly Linked Chain

dequeue

**An Alternative:
A Circular Linked Chain**

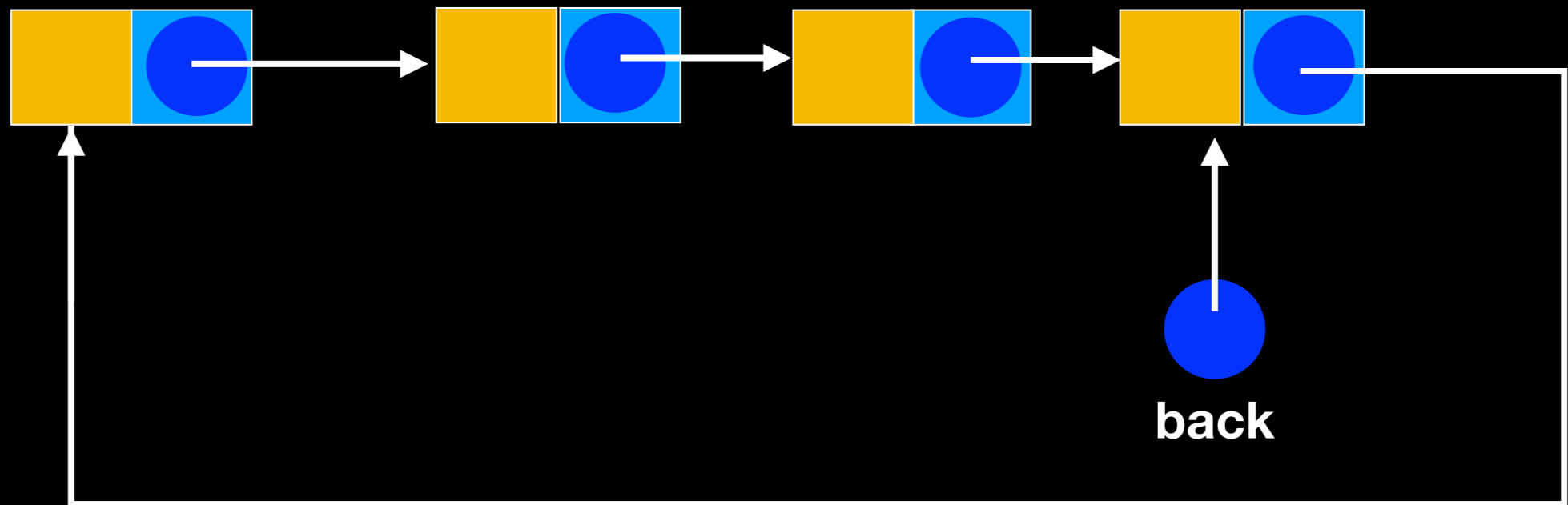

Singly Linked Chain

dequeue

An Alternative:
A Circular Linked Chain

```
temp = back->getNext()
```

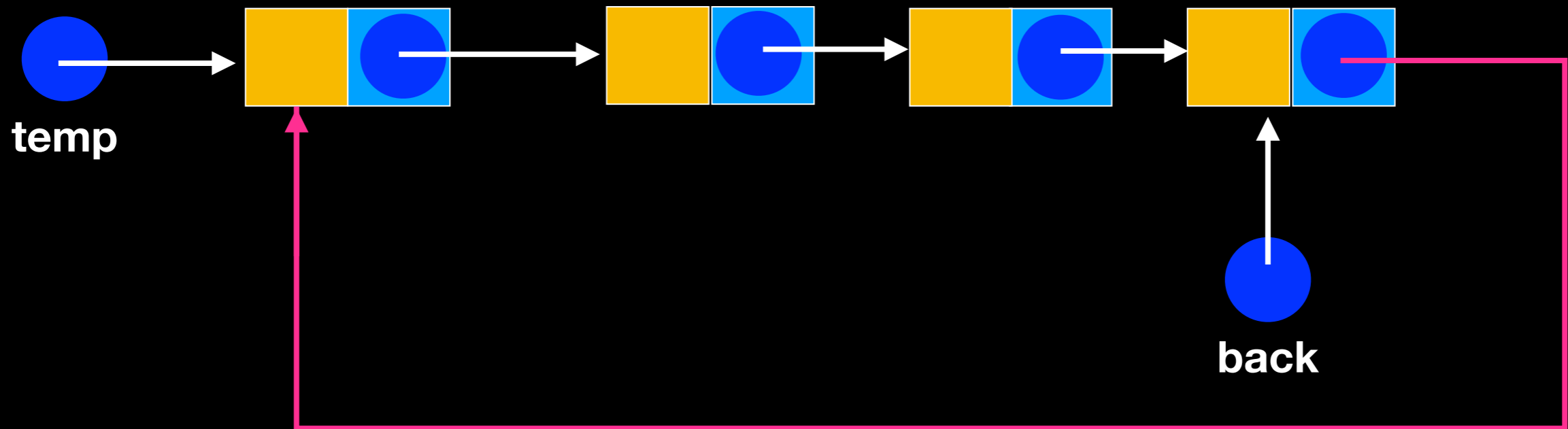

Singly Linked Chain

dequeue

An Alternative:
A Circular Linked Chain

```
back->setNext (back->getNext ()->getNext ())
```

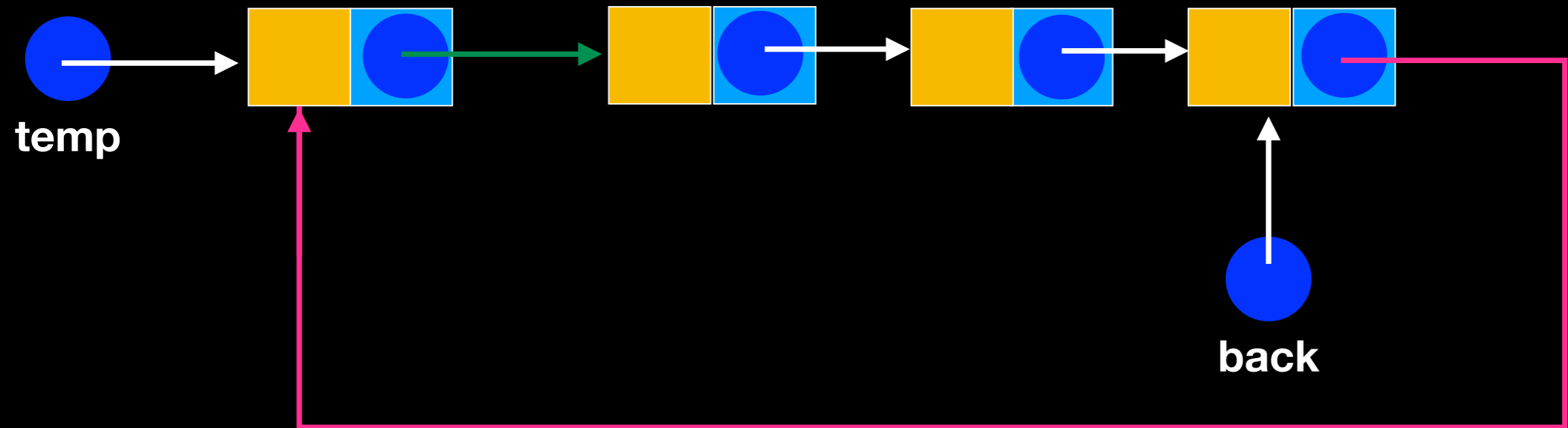

Singly Linked Chain

dequeue

An Alternative:
A Circular Linked Chain

```
back->setNext (back->getNext ()->getNext ())
```

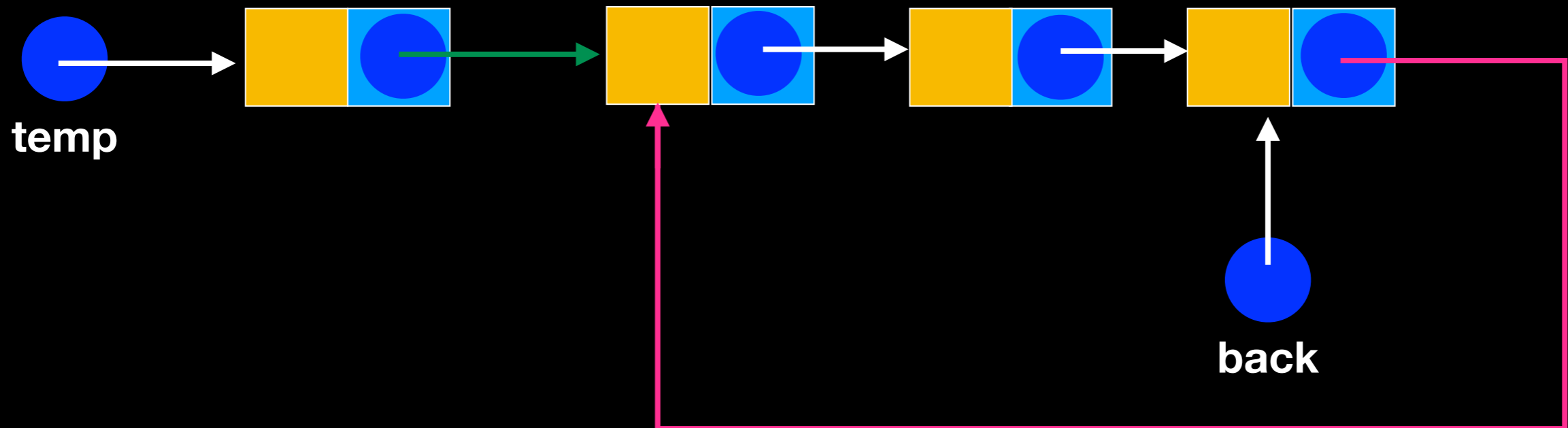

Singly Linked Chain

dequeue

An Alternative:
A Circular Linked Chain

```
temp->setNext(nullptr);  
delete temp;
```

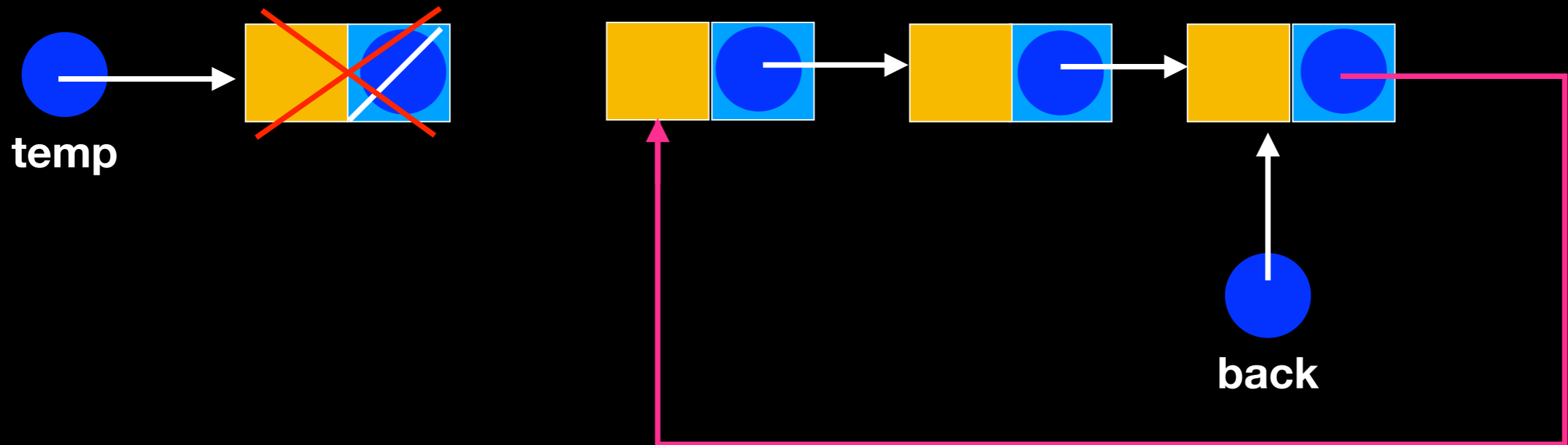

Singly Linked Chain

dequeue

An Alternative:
A Circular Linked Chain

`back->getNext()` is the front pointer!

temp

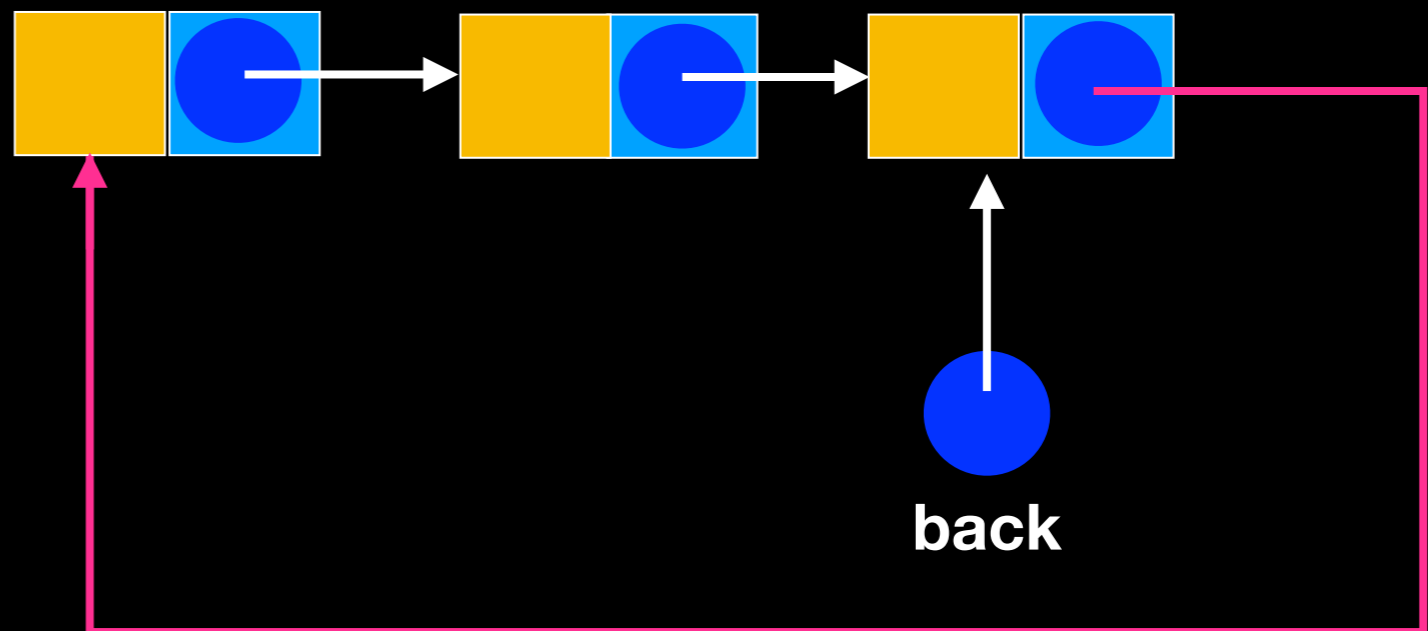

Queue ADT

(Circular Linked Chain)

```
#ifndef QUEUE_H_
#define QUEUE_H_

template<class T>
class Queue
{
public:
    Queue();
    Queue(const Queue<T>& a_queue); // Copy constructor
    ~Queue();
    void enqueue(const T& new_entry); // adds an element to back queue
    void dequeue(); // removes element from front of queue
    T front() const; // returns a copy of element at the front of queue
    int size() const; // returns the number of elements in the queue
    bool isEmpty() const; // returns true if no elements in queue, false otherwise

private:
    Node<T>* back_; // Pointer to back of queue
    int item_count; // number of items currently on the stack
}; //end Queue

#include "Queue.cpp"
#endif // QUEUE_H_`
```

Lecture Activity

How would you implement it
using an array?
enqueue and dequeue in $O(1)$

Array Considerations

front = ?
back = ?

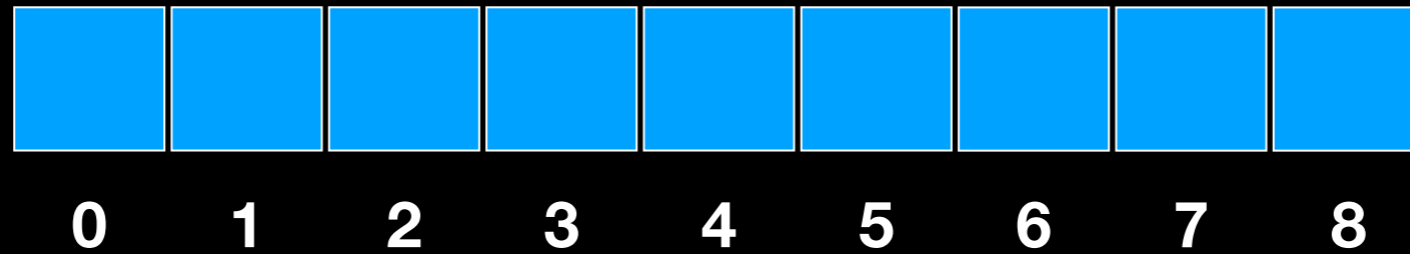

Array Considerations

`front = 0`
`back = -1`

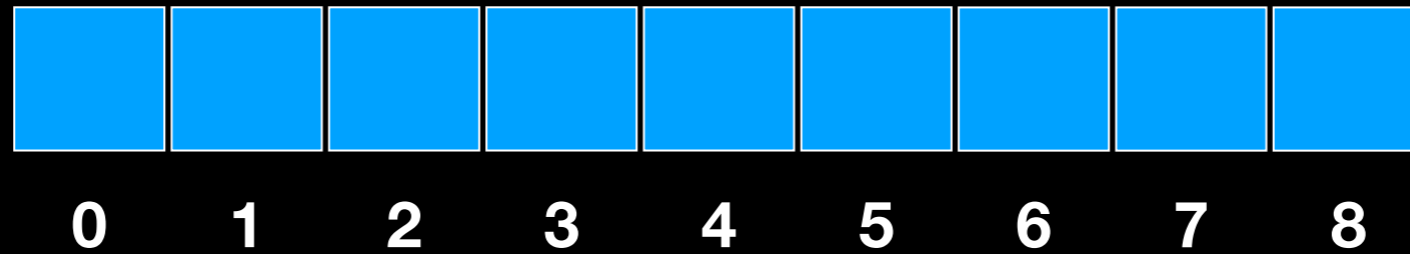

Array Considerations

enqueue

Increment back and add
element to `items_[back]`

`front = 0`

`back = -1`

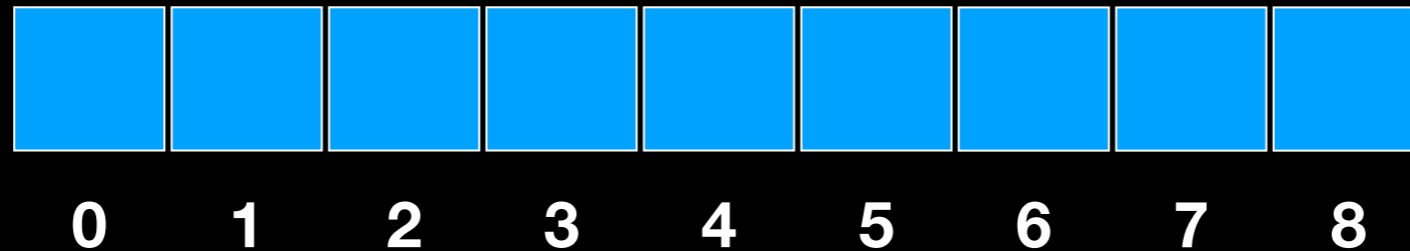

Array Considerations

enqueue

Increment back and add
element to `items_[back]`

`front = 0`

`back = 0`

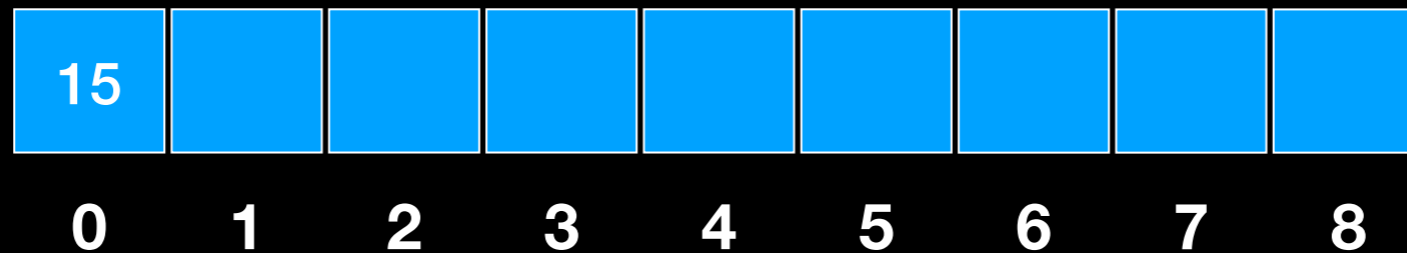

Array Considerations

enqueue

Increment back and add
element to `items_[back]`

`front = 0`

`back = 1`

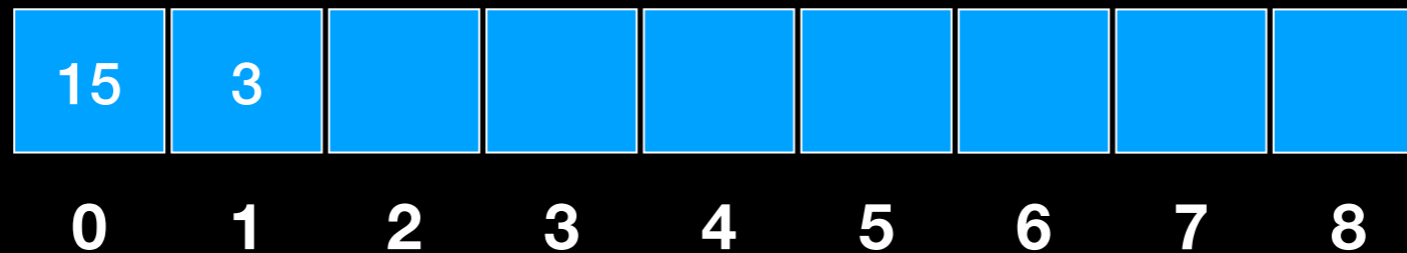

Array Considerations

enqueue

Increment back and add
element to `items_[back]`

`front = 0`

`back = 2`

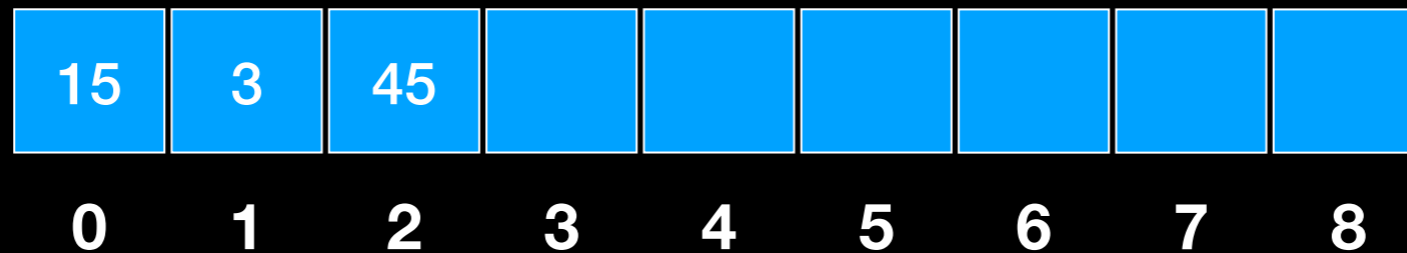

Array Considerations

enqueue

Increment back and add
element to `items_[back]`

`front = 0`
`back = 5`

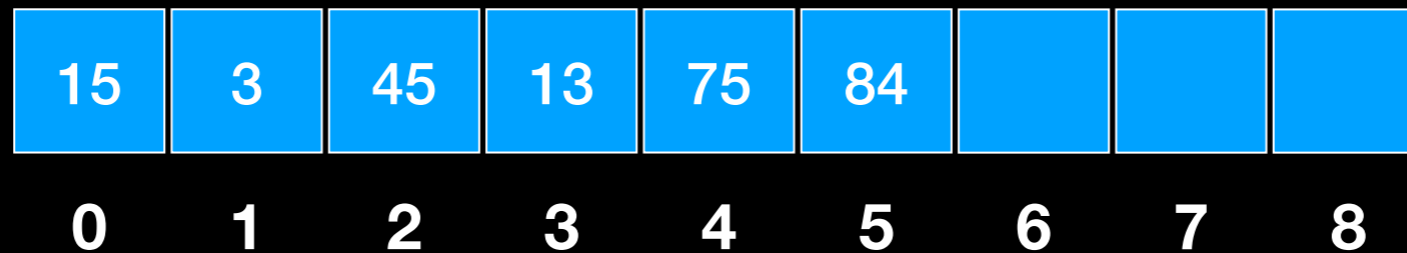

This seems to work, but what happens when we start dequeuing?

Array Considerations

dequeue

Increment front

front = 1
back = 5

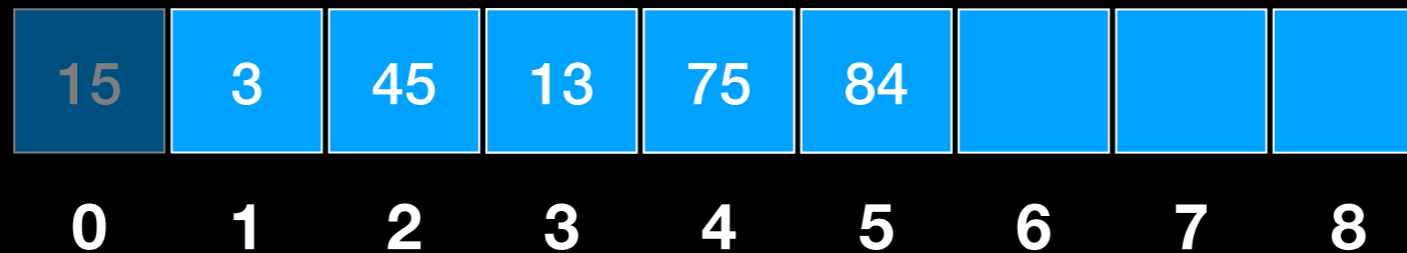

We want $O(1)$ operations, so simply increment front!

Array Considerations

dequeue

Increment front

front = 2

back = 5

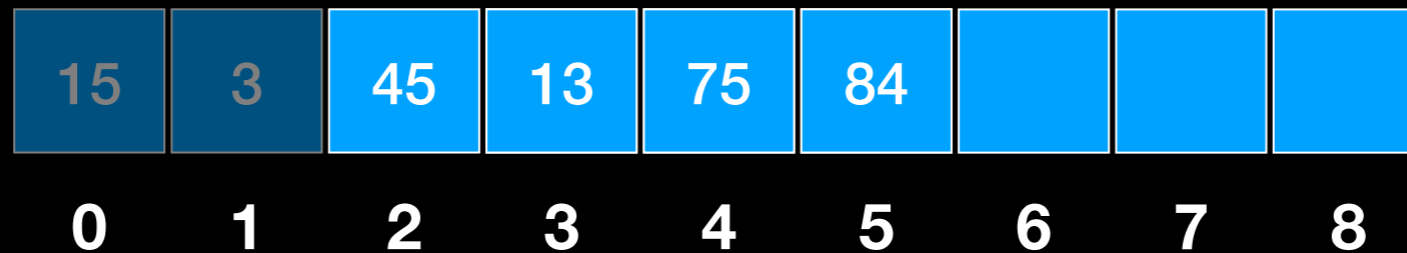

Array Considerations

`front = 6`
`back = 8`

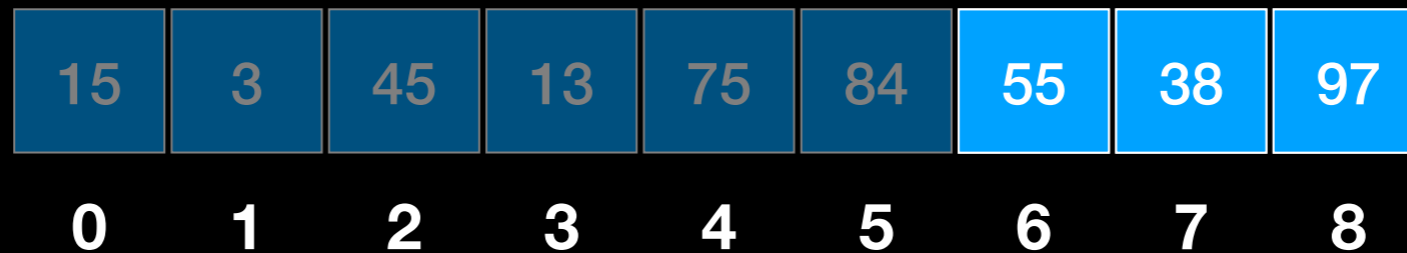

RIGHTWARD DRIFT!!!

At some point queue will be full even if it contains only a few elements

Array Considerations

`front = 6`
`back = 8`

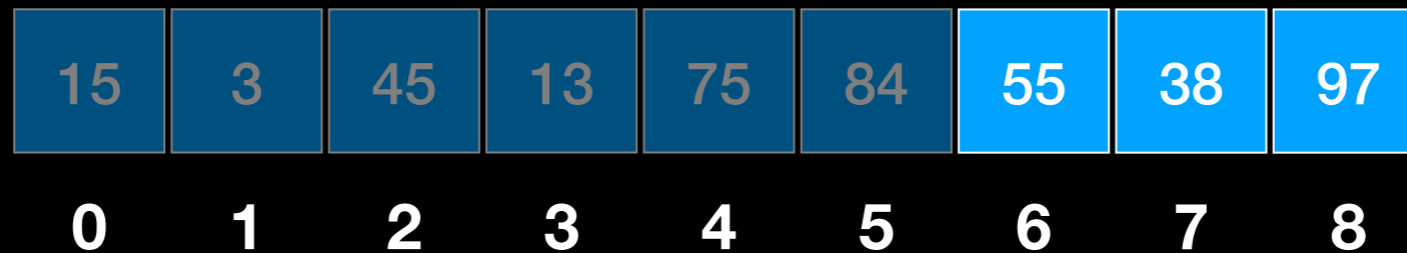

RIGHTWARD DRIFT!!!

At some point queue will be full even if it contains only a few elements

No
Good

Circular Array Implementation

`front = 0`
`back = -1`

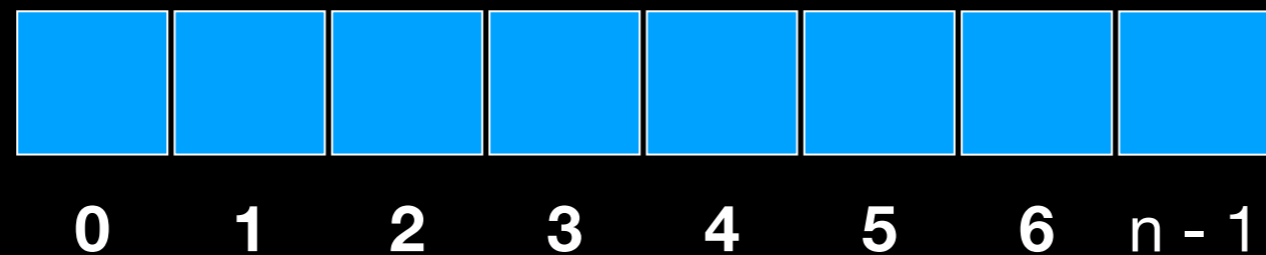

Circular Array Implementation

`front = 0`
`back = 3`

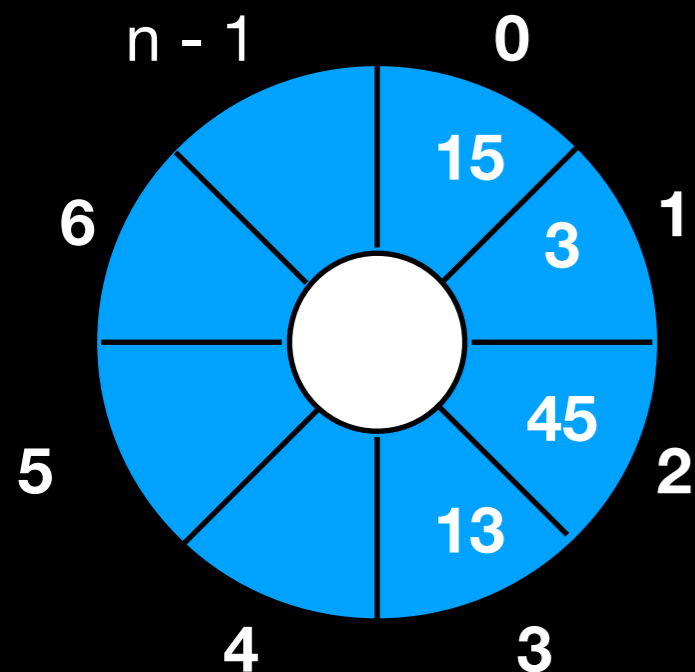
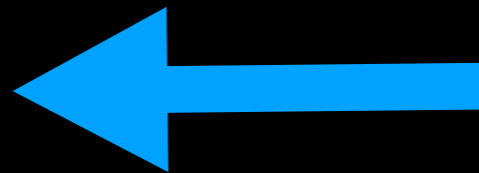
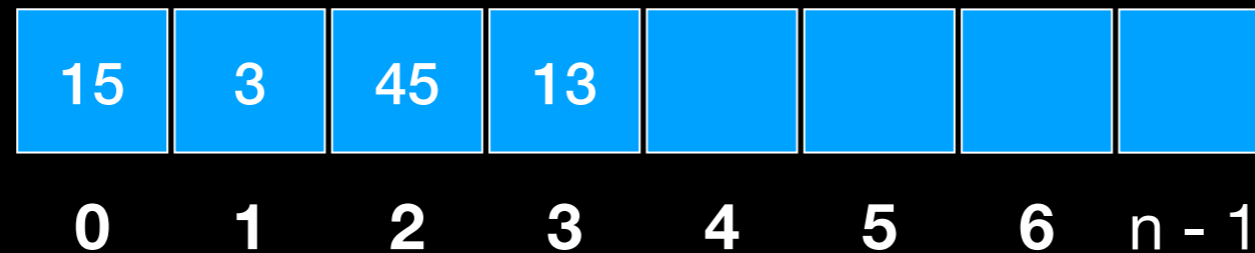

Circular Array Implementation

`front = 2`
`back = 3`

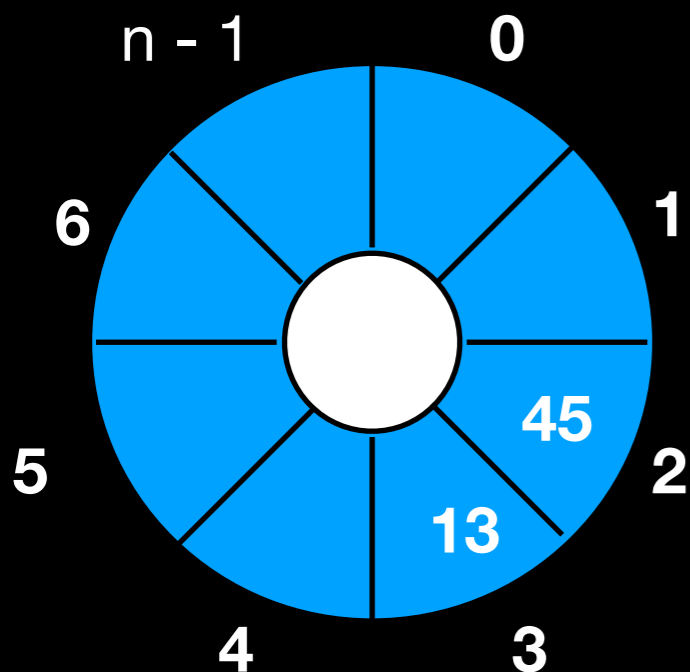
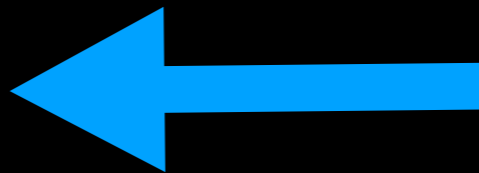
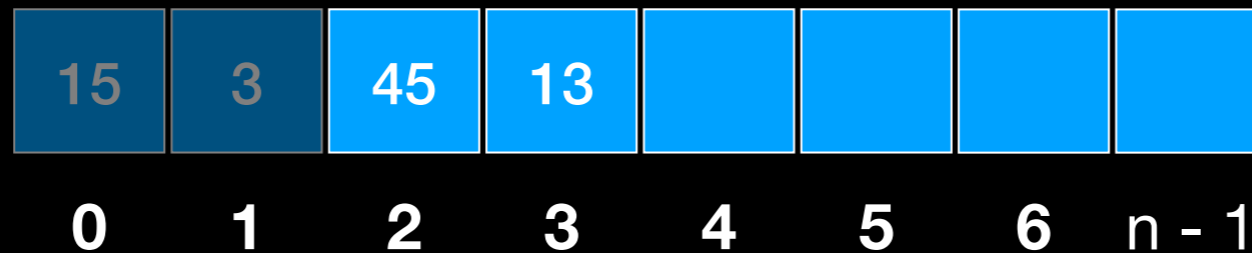

Circular Array Implementation

`front = 6`

`back = n - 1`

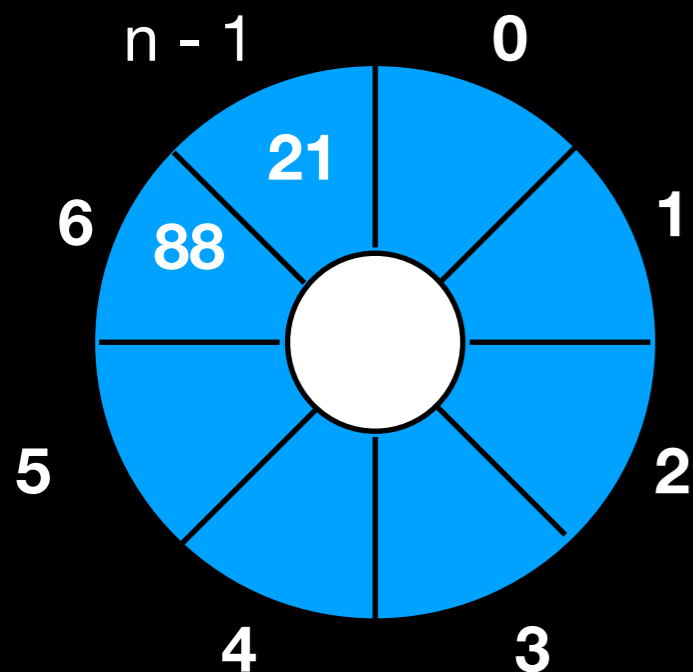
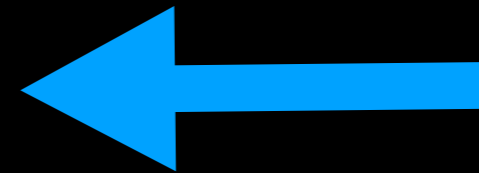
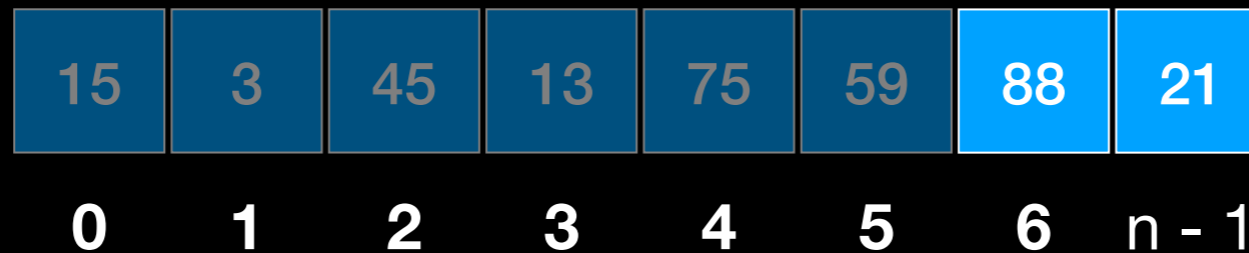

Circular Array Implementation

`front = 6`

`back = 0`

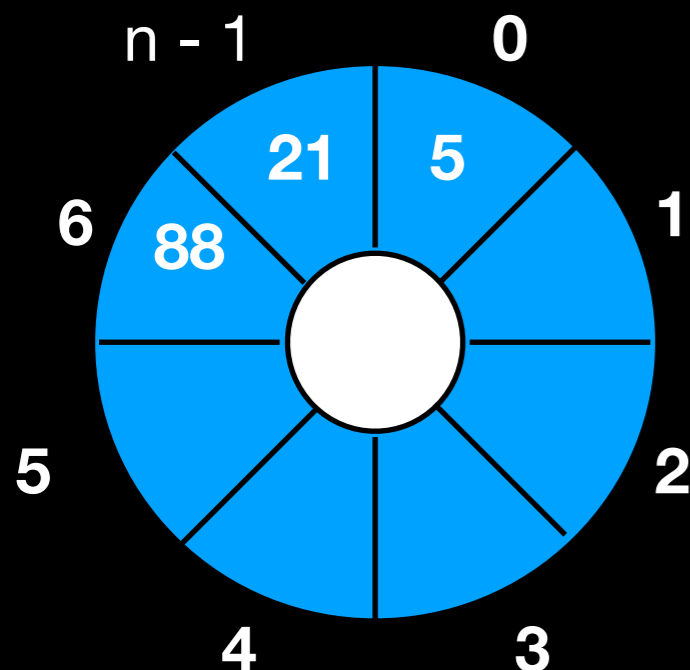
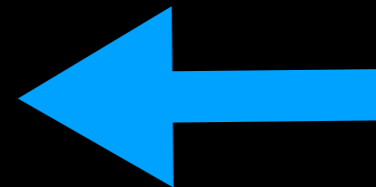

WRAP AROUND USING
MODULO ARITHMETIC

Circular Array Implementation

enqueue

```
back = (back + 1) % n  
add element to items_[back]
```

front = 6

back = 0

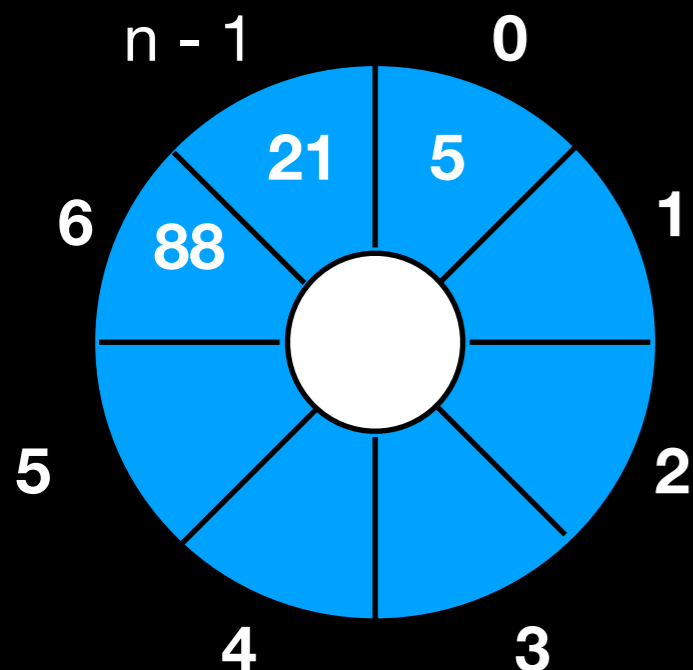
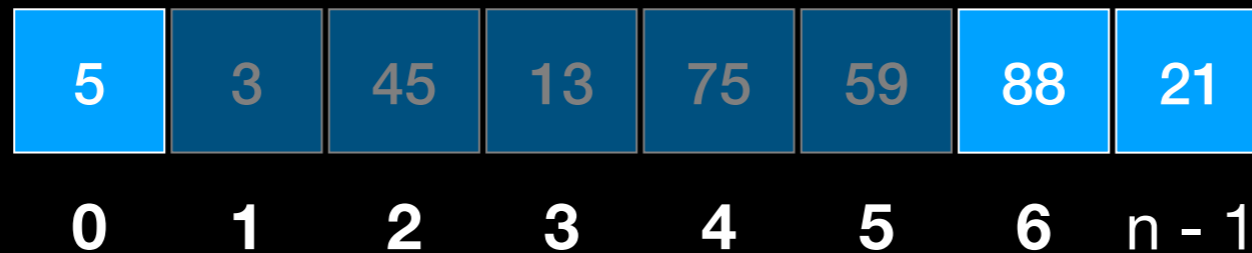

Circular Array Implementation

`front = n-1`

`back = 2`

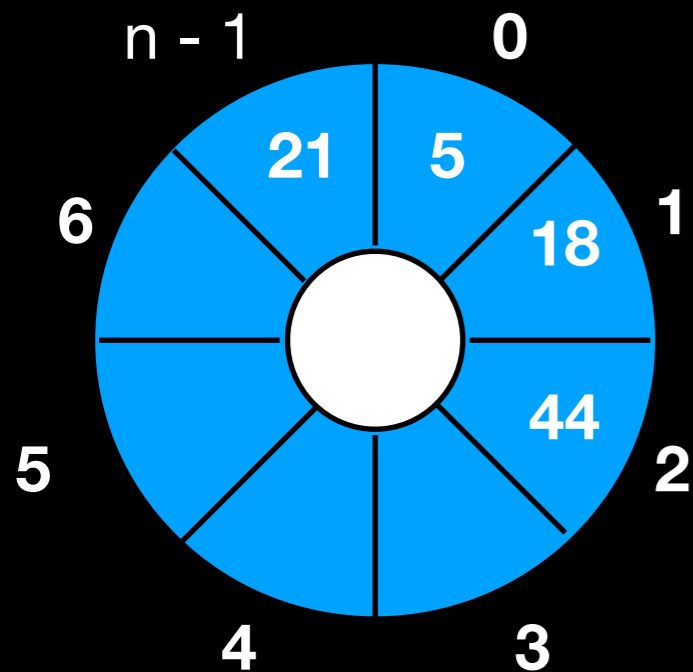
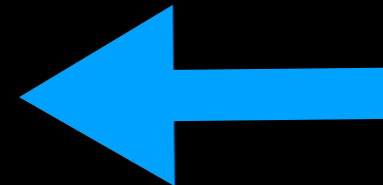
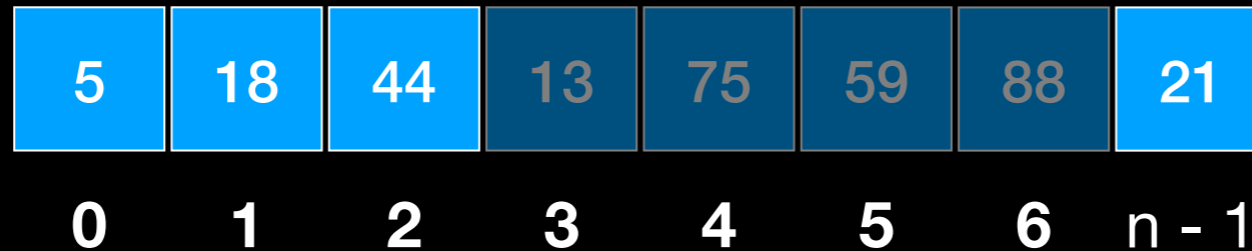

Circular Array Implementation

dequeue

$$\text{front} = (\text{front} + 1) \% n$$

front = n-1

back = 2

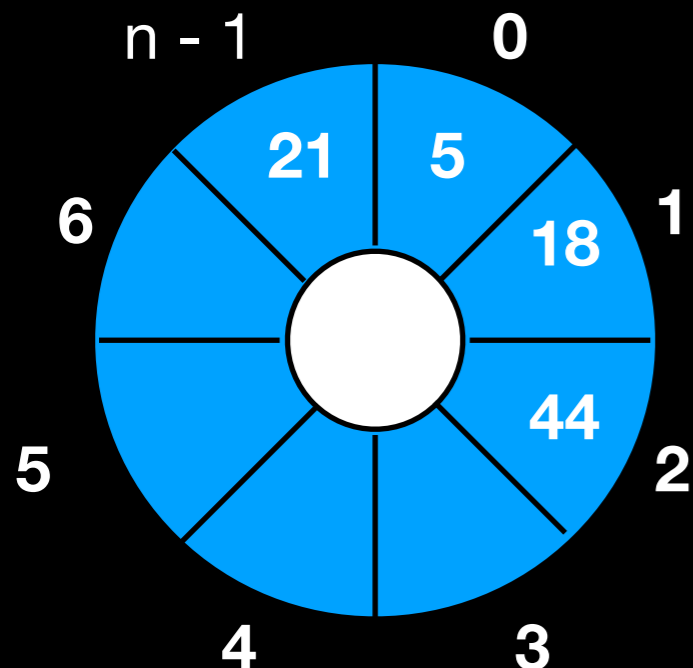
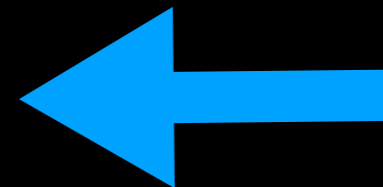

Circular Array Implementation

dequeue

$$\text{front} = (\text{front} + 1) \% n$$

front = 0

back = 2

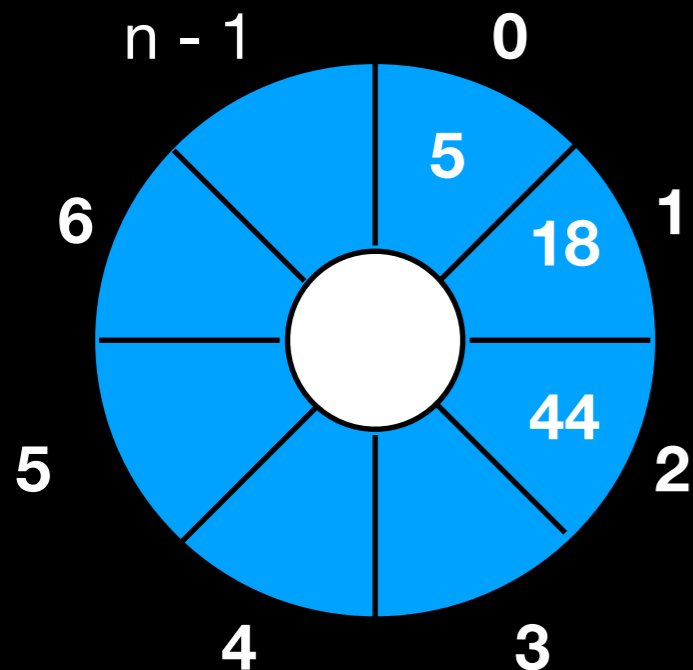

Circular Array Implementation

front = 2

back = 2

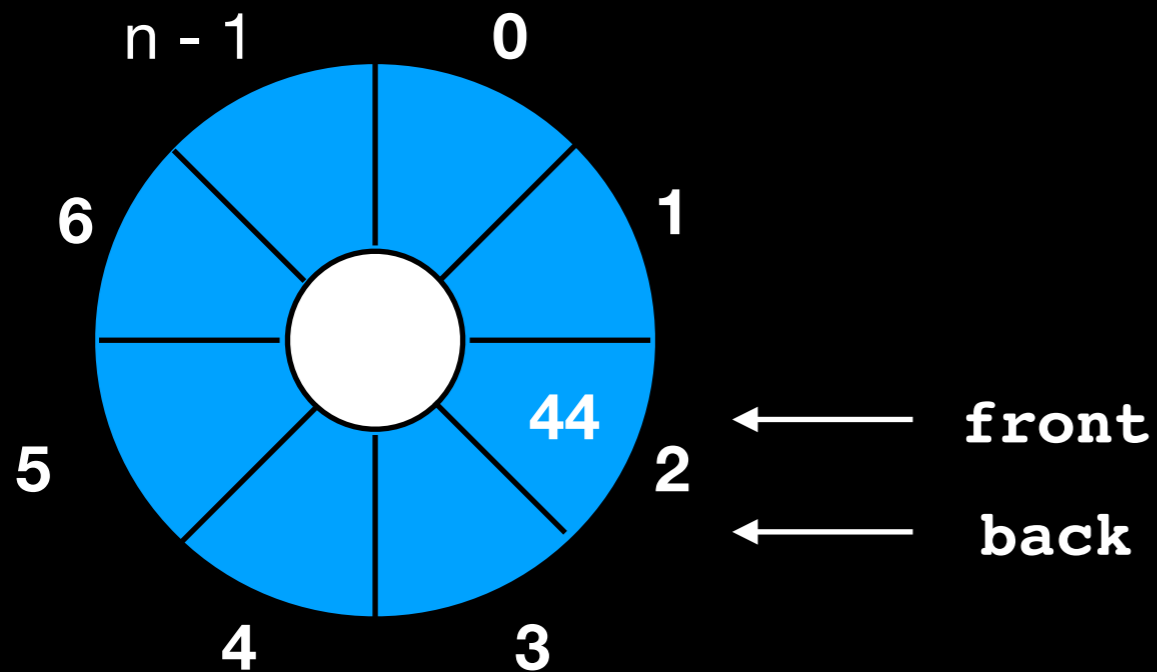
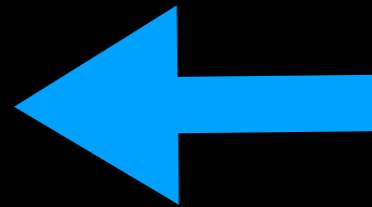

Circular Array Implementation

dequeue

$$\text{front} = (\text{front} + 1) \% n$$

front = 3

back = 2

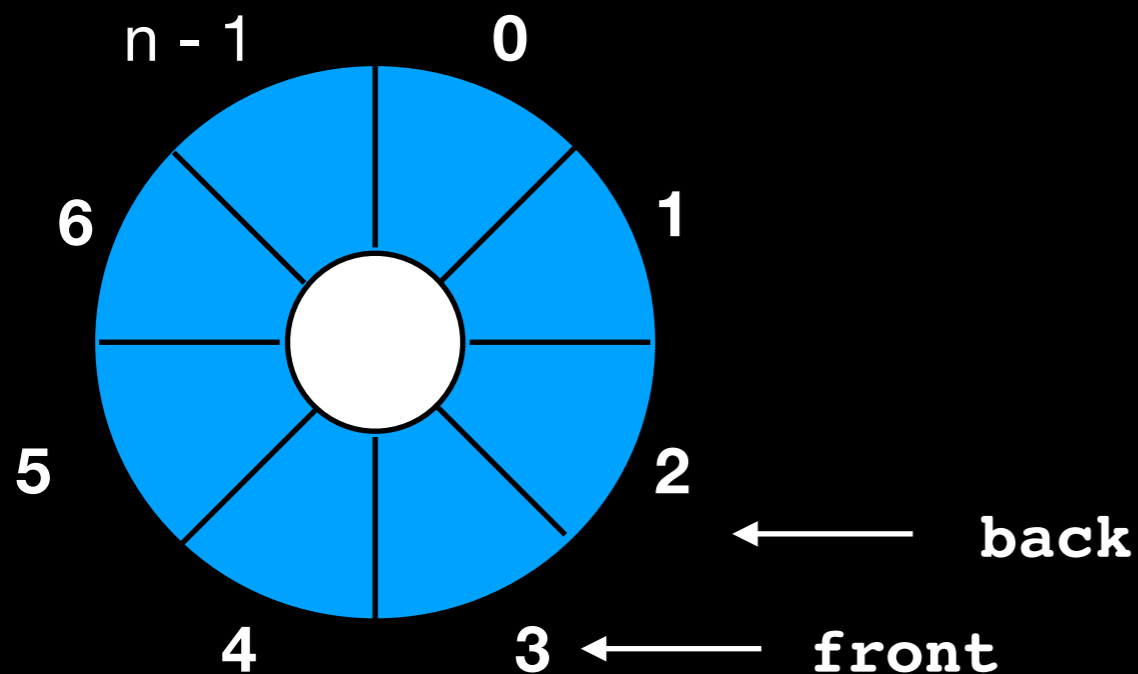
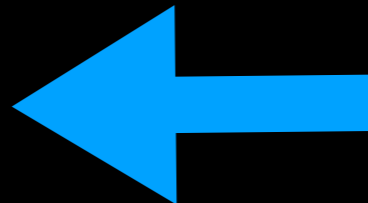
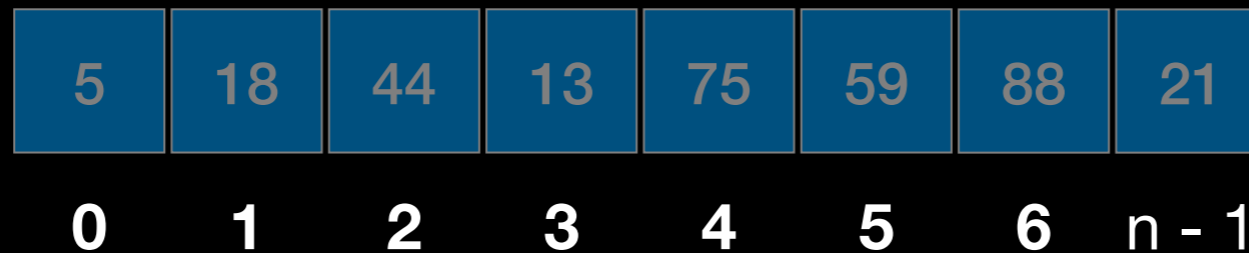

front passes back when queue is EMPTY

Circular Array Implementation

enqueue

```
back = (back + 1) % n  
add element to items_[back]
```

front = 3

back = 1

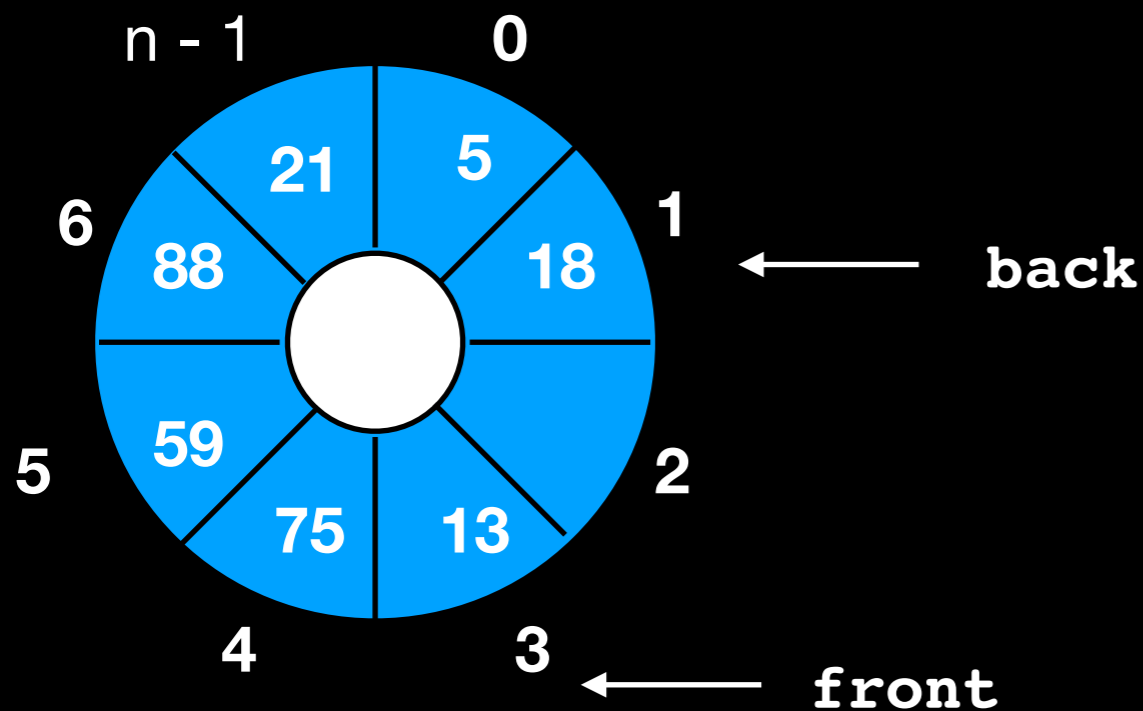
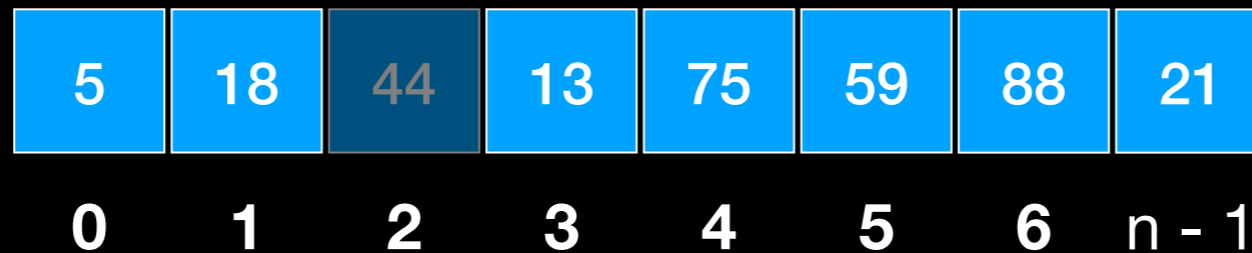

Circular Array Implementation

enqueue

$back = (back + 1) \% n$
add element to `items_[back]`

`front = 3`

`back = 2`

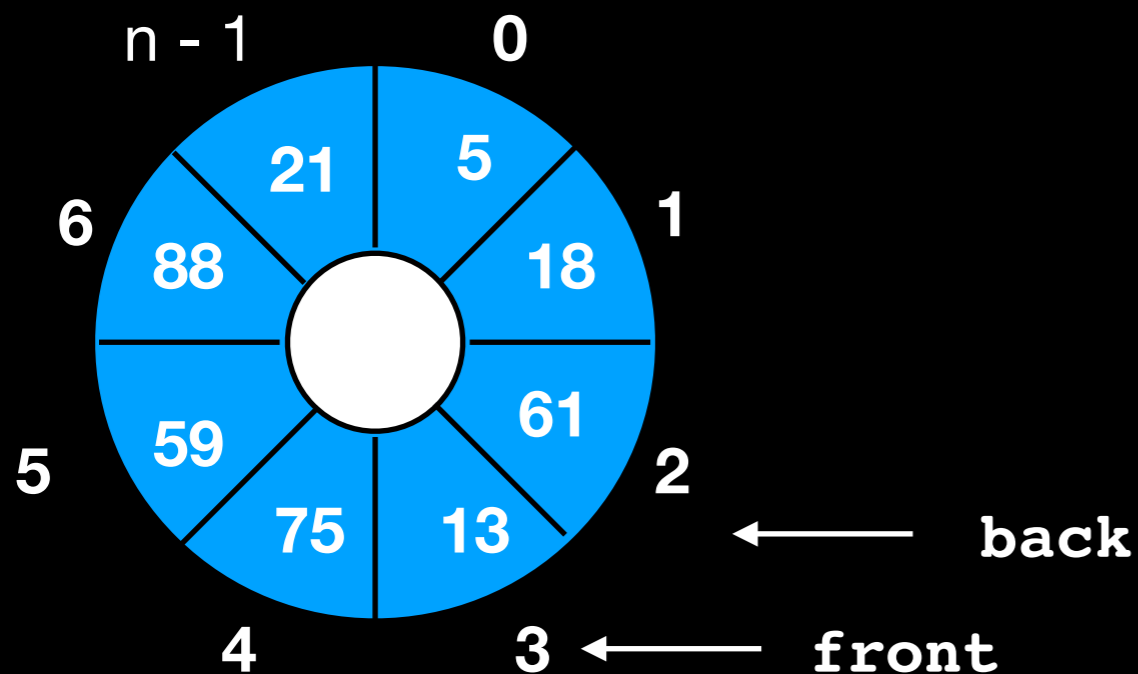
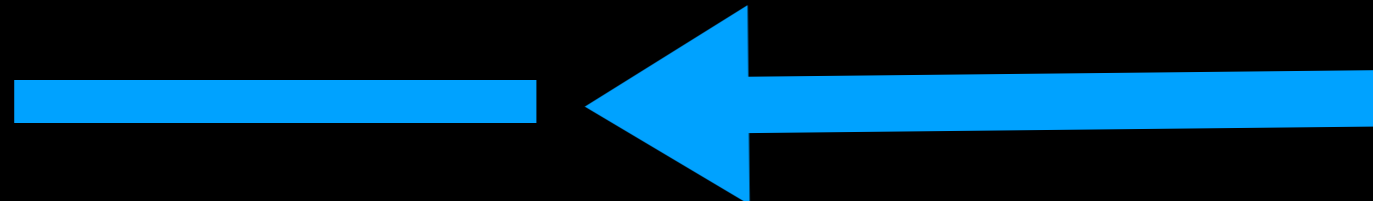
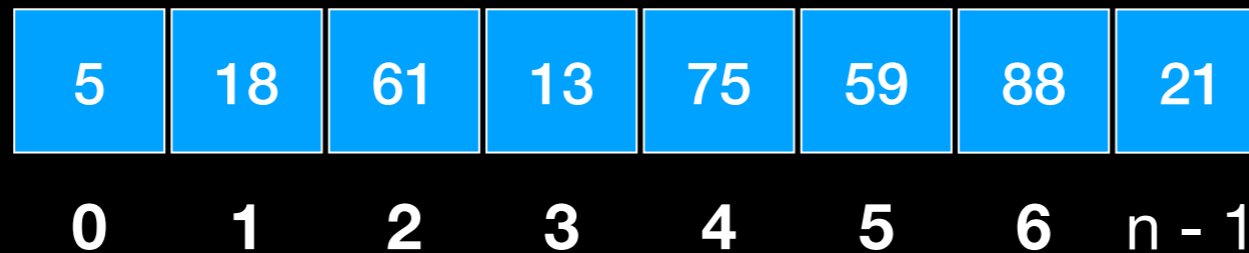

front passes back **ALSO**
when queue is **FULL**

Circular Array Implementation

enqueue

$back = (back + 1) \% n$
add element to `items_[back]`

`front = 3`

`back = 2`

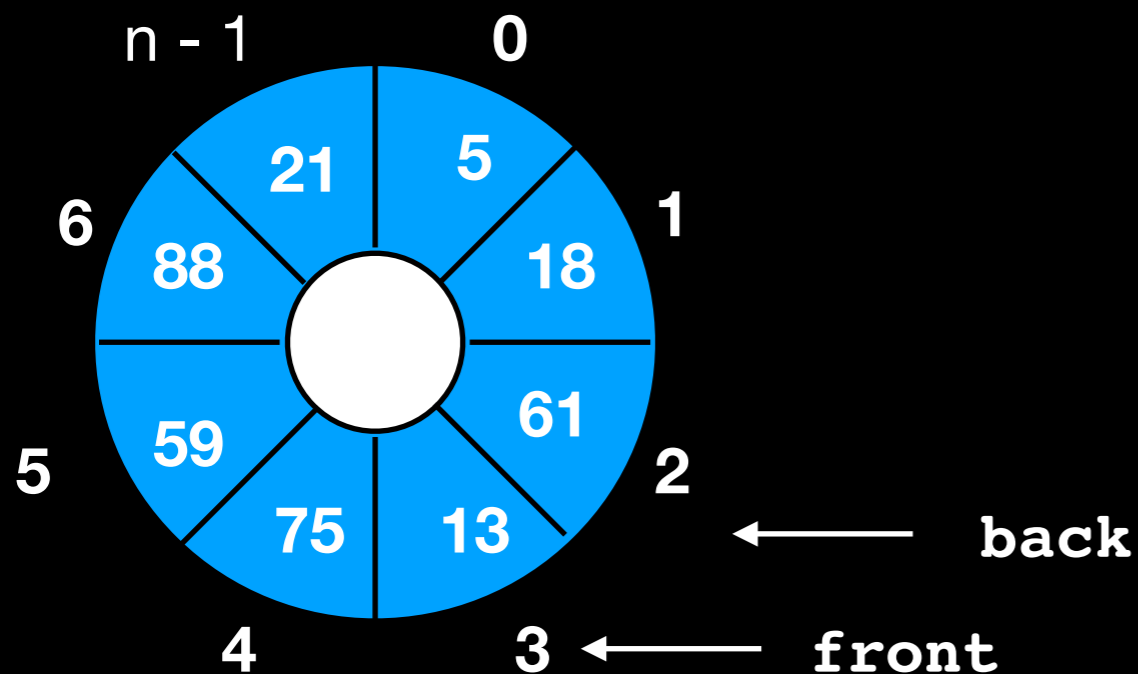
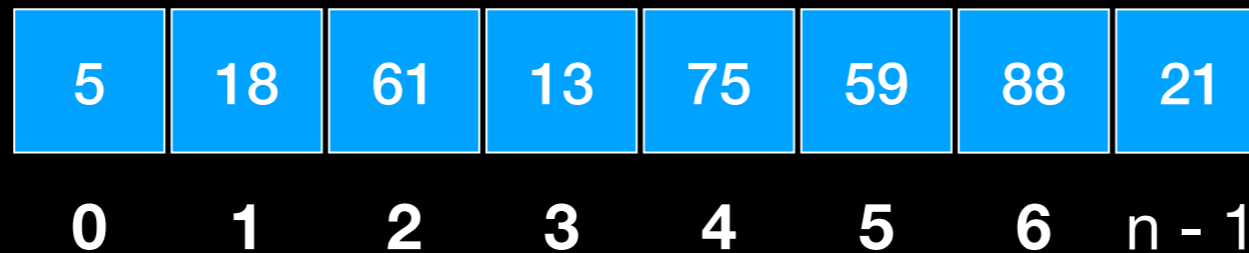

To distinguish between **empty** and **full** queue must keep a **COUNTER** for number of items